



# TruVision DVR 41 User Manual

**Copyright** © 2013 UTC Fire & Security Americas Corporation, Inc.  
Interlogix is part of UTC Climate Controls & Security, a unit of United Technologies Corporation. All rights reserved.

**Trademarks and patents** The TruVision and Interlogix names and logos are trademarks of United Technologies.

Other trade names used in this document may be trademarks or registered trademarks of the manufacturers or vendors of the respective products.

**Manufacturer** UTC Fire & Security Americas Corporation, Inc.  
2955 Red Hill Avenue, Costa Mesa, CA 92626-5923, USA

Authorized EU manufacturing representative:  
UTC Fire & Security B.V.  
Kelvinstraat 7, 6003 DH Weert, The Netherlands

**Certification**   N4131

**FCC compliance** **Class B:** This equipment has been tested and found to comply with the limits for a Class B digital device, pursuant to part 15 of the FCC Rules. These limits are designed to provide reasonable protection against harmful interference in a residential installation. This equipment generates, uses, and can radiate radio frequency energy and, if not installed and used in accordance with the instructions, may cause harmful interference to radio communications.

There is no guarantee that interference will not occur in a particular installation. If this equipment does cause harmful interference to radio or television reception, which can be determined by turning the equipment off and on, the user is encouraged to try to correct the interference by one or more of the following measures:

- Reorient or relocate the receiving antenna.
- Increase the separation between the equipment and receiver.
- Connect the equipment into an outlet on a circuit different from that to which the receiver is connected.
- Consult the dealer or an experienced radio/TV technician for help.

**European Union directives** **12004/108/EC (EMC directive):** Hereby, UTC Fire & Security declares that this device is in compliance or with the essential requirements and other relevant provisions of Directive 2004/108/EC.



**2002/96/EC (WEEE directive):** Products marked with this symbol cannot be disposed of as unsorted municipal waste in the European Union. For proper recycling, return this product to your local supplier upon the purchase of equivalent new equipment, or dispose of it at designated collection points. For more information see: [www.recyclethis.info](http://www.recyclethis.info).

**2006/66/EC (battery directive):** This product contains a battery that cannot be disposed of as unsorted municipal waste in the European Union. See the product documentation for specific battery information. The battery is marked with this symbol, which may include lettering to indicate cadmium (Cd), lead (Pb), or mercury (Hg). For proper recycling, return the battery to your supplier or to a designated collection point. For more information see: [www.recyclethis.info](http://www.recyclethis.info).

**Contact information** For contact information, see [www.utcfireandsecurity.com](http://www.utcfireandsecurity.com) or [www.utcfssecurityproducts.eu](http://www.utcfssecurityproducts.eu)

# Content

<b>Chapter 1</b>	<b>Product introduction 1</b>
	Product overview 1
<b>Chapter 2</b>	<b>Installation 3</b>
	Installation environment 3
	Unpacking the TVR 41 and its accessories 3
	Back panel 4
	PTZ dome camera set up 5
	Wiring the keypad 10
	RS-485 ports 12
	RS-232 port 13
	Monitor connections 13
	Loop through 13
	Audio inputs and output 13
	Brackets 14
<b>Chapter 3</b>	<b>Getting started 15</b>
	Turning on and off the DVR 15
	Using the setup wizard 16
<b>Chapter 4</b>	<b>Operating instructions 19</b>
	Controlling the TVR 41 19
	Using the front panel 19
	Using the mouse 21
	Using the IR remote control 22
	Menu overview 25
<b>Chapter 5</b>	<b>Live view 29</b>
	Description of live view 29
	Video output 29
	Audio output 30
	Controlling live view 30
	Multiview format 32
	Sequencing cameras 33
	Accessing frequently used commands 34
	Configuring live view 35
	Configuring time and date 38
	General settings 39
	V-stream encoding 42
<b>Chapter 6</b>	<b>Controlling a PTZ camera 43</b>
	Configuring PTZ settings 43
	Calling up presets, tours and shadow tours 44
	Setting and calling up presets 45

Setting and calling up preset tours 47  
Setting and calling up a shadow tour 48

**Chapter 7**      **Playing back a recording 51**  
Overview of the playback window 51  
Playback pop-up menu 54  
Instant playback 54  
All-day playback 55  
Searching recorded video 56  
Playing back recordings by time and video type 57  
Playing back recordings by event 58  
Creating and playing back bookmarked recordings 59  
Slideshow of snapshots 60  
Playing back recordings from the system log 60  
Playback skip time 61  
Motion search 62  
Playing back frame-by-frame 62  
Digital zoom in playback 63

**Chapter 8**      **Archiving recorded files 65**  
Archiving files 65  
Auto archiving 68  
Creating and archiving video clips 69  
Archiving snapshots 69  
Managing backup devices 70  
Playing back archived files on a PC 70

**Chapter 9**      **Using the web browser 71**  
Windows Vista and 7 users 71  
Accessing the web browser 72  
Web browser overview 72  
Using the web browser to configure the device 74  
Searching and playing back recorded video 77  
Searching for event logs 79  
Dual streaming 80  
Controlling a PTZ dome camera in the web browser 81  
Capturing text insertions 81  
Text overlay 83  
Using a network storage system 84

**Chapter 10**     **Recording 87**  
Initializing recording settings 87  
Defining a recording schedule 90  
Daily schedules 91  
Holiday schedules 92  
Manual recording 93  
Motion detection schedules 93  
External alarm schedules 93

	Protecting recorded files	94
	HDD redundancy	95
<b>Chapter 11</b>	<b>Alarm settings</b>	<b>97</b>
	Description of alarm notification types	97
	Setting up motion detection	100
	Setting up external alarms	102
	Triggering or clearing alarm outputs manually	104
	Setting up system notifications	105
	Detecting video loss	105
	Detecting video tampering	106
<b>Chapter 12</b>	<b>Network settings</b>	<b>109</b>
	Configuring general network settings	109
	Configuring PPPoE	110
	Configuring DDNS	111
	Configuring an NTP server	112
	Configuring e-mail	112
	Configuring UPnP	113
	Configuring SNMP	115
	Configuring an FTP server to store snapshots	115
	Configuring a remote alarm host	115
	Configuring multicast	116
	Configuring the server and HTTP ports	116
	Configuring the RTSP service port	116
	Checking network status	117
	Exporting network packet data	118
	Bandwidth throttle management	118
<b>Chapter 13</b>	<b>HDD management</b>	<b>121</b>
	Initializing HDDs	121
	Controlling disk space on the HDD	121
	Setting up HDD groups	122
	Recording dual streaming	123
	Setting the HDD property	123
	Checking HDD status	124
	Configuring HDD alarms	124
	Managing eSATA	125
	Checking the S.M.A.R.T. information	125
	Searching video using disk analysis	126
<b>Chapter 14</b>	<b>Camera settings</b>	<b>129</b>
	Configuring the camera OSD settings	129
	Setting up privacy masking	130
	Adjusting camera image settings	131
	Hiding a camera image from view	131

<b>Chapter 15</b>	<b>DVR management 133</b>
	Configuring the RS-232 port 133
	Updating system firmware 134
	Restoring default settings 135
	Viewing system information 136
	Searching system logs for events 137
	Importing and exporting configuration settings 138
<b>Chapter 16</b>	<b>User management 139</b>
	Adding a new user 139
	Customizing a user's access privileges 140
	Deleting a user 141
	Modifying a user 142
	Changing the Admin password 142
<b>Chapter 17</b>	<b>iTVRmobile 143</b>
	Setup and login 143
	Live view 144
	Controlling a PTZ camera 145
	Device management 146
	Favorites 147
	Local configuration 148
	Change passwords 148
	Snapshots 148
<b>Appendix A</b>	<b>Specifications 149</b>
<b>Appendix B</b>	<b>PTZ protocols 151</b>
<b>Appendix C</b>	<b>Port forwarding information 153</b>
<b>Appendix D</b>	<b>KTD-405 keypad 155</b>
	Supported firmware 155
	Wiring the keypad 155
	Setting up the keypad to work with the TVR 41 156
	Operating the keypad 158
<b>Appendix E</b>	<b>Maximum pre-recording times 163</b>
<b>Appendix F</b>	<b>Supported PTZ commands 165</b>
<b>Appendix G</b>	<b>Default menu settings 167</b>
	<b>Index 177</b>

# Chapter 1

## Product introduction

### Product overview

This is the TruVision DVR 41(TVR 41) User Manual for models:

**Table 1: Product codes**

Americas	EMEA
TVR-4108-2T	TVR-4104-1TEA
TVR-4108-4T	TVR-4104-2TEA
TVR-4116-2T	TVR-4108-2TEA
TVR-4116-4T	TVR-4108-4TEA
TVR-4116-8T	TVR-4116-2TEA
TVR-4116-12T	TVR-4116-4TEA
	TVR-4116-8TEA
	TVR-4116-12TEA

**Note:** Models are shipped with the power chords for their region.

For regions not listed in Table 1 above, please contact your local supplier.

The TruVision™ DVR 41 (TVR 41) is a versatile, user-friendly embedded digital video recorder (DVR) allowing end-users to record 4, 8, or 16 analog cameras at 4 CIF in real time (25/30 fps), while providing integration with the UTC portfolio of security solutions, and offering a seamless product experience within the TruVision brand.

Its dual streaming functionality allows the user to set up different settings for recording and streaming video in live view mode.

TruVision DVR 41 can fully integrate with the license-free TruVision Navigator software, which is ideal for the most commercial applications. TVR 41's easy and intuitive-to-use web browser interface enables remote configuration and secure viewing, searching, and playing back of video from computers connected via the Internet.





# Chapter 2

## Installation

This section describes how to install the TVR 41 unit.

### Installation environment

When installing your product, consider these factors:

- Ventilation
- Temperature
- Moisture
- Chassis load

**Ventilation:** Do not block any ventilation openings. Install in accordance with the manufacturer's instructions. Ensure that the location planned for the installation of the unit is well ventilated.

**Temperature:** Consider the unit's operating temperature (-10 to +55 °C, 14 to 131 °F) and noncondensing humidity specifications (10 to 90%) before choosing an installation location. Extremes of heat or cold beyond the specified operating temperature limits may reduce the life expectancy of the DVR. Do not install the unit on top of other hot equipment. Leave 44 mm (1.75 in.) of space between rack-mounted TruVision DVR 41 units.

**Moisture:** Do not use the unit near water. Moisture can damage the internal components. To reduce the risk of fire or electric shock, do not expose this unit to rain or moisture.

**Chassis:** Equipment weighing less than 15.9 kg (35 lb.) may be placed on top of the unit.

### Unpacking the TVR 41 and its accessories

When you receive the product, check the package and contents for damage, and verify that all items are included. There is an item list included in the package. If any of the items are damaged or missing, please contact your local supplier.

Items shipped with the product include:

- IR (infrared) remote control
- Two AAA batteries for the remote control
- AC power cords (US, Europe, UK)
- USB mouse
- DVR
- Video loop through cable
- CD with software and manuals
- *TruVision DVR 41 Quick Start Guide*
- *TruVision DVR 41 User Manual (on CD)*

## Back panel

Figure 1 on page 5 shows the back panel connections and describes each connector on a typical TVR 41 digital video recorder. Details may vary for specific models.

Before powering up the DVR, connect the cameras and a main monitor for basic operation.

Figure 1: Back panel connections

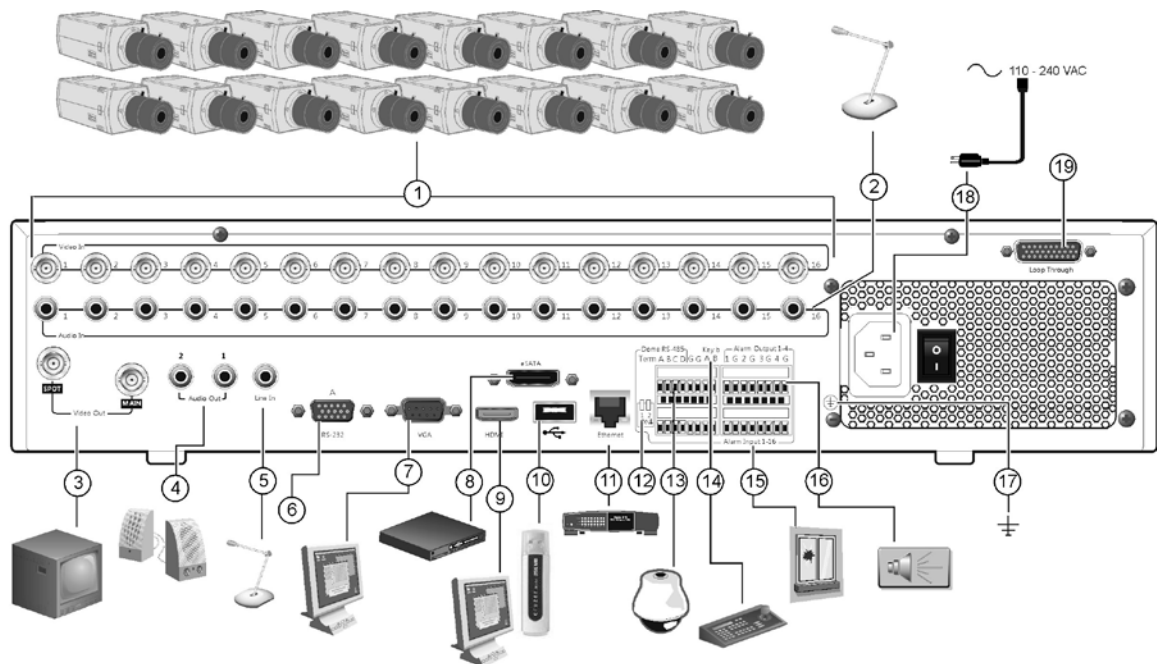

1. Connect up to 16 analog cameras to BNC connectors.
2. Connect audio inputs (available for each camera) to RCA connectors.
3. Connect up to two CCTV monitors (BNC-type connectors):
  - Spot monitor
  - Main monitor
4. Connect to speakers for audio output.
5. Connect RCA connector to a microphone.
6. Connect to a RS-232 device.
7. Connect to a VGA monitor.
8. Connect to an optional eSATA device such as SATA HDD, CD/DVD-RM.
9. Connect to a HDTV. The HDMI connection supports both digital audio and video.
10. Connect to an optional USB device such as a mouse, CD/DVD burner or HDD. The DVR supports both a USB DVD and a USB HD on the front and back USB ports.
11. Connect to a network.
12. Terminate the line to the dome cameras using this RS-485 switch. Default is Off.
13. Connect to a PTZ control.
14. Connect to a keyboard (KTD-405 shown)
15. Connect up to 16 alarm input cables to relay outputs.
16. Connect up to four alarm relay outputs.
17. Connect to ground.
18. Connect to a power supply.
19. Loop through for up to 16 analog cameras (see item 1).

## PTZ dome camera set up

Use the USB mouse provided or the optional keypad for local telemetry control. If using the TVR 41 over a network, use the web browser to control the PTZ dome cameras or TruVision Navigator.

See Appendix B on page 151 for the supported protocols and Appendix F on page 165 for the PTZ commands supported by each protocol.

Each PTZ camera must be set up individually. For information on configuring PTZ dome camera settings, see Chapter 6, “Controlling a PTZ camera” on page 43.

## Connecting a TVR 41 to a PTZ dome camera and a keypad

Use the input/output box that is supplied with the keypad to connect a keypad to the TVR 41. The keypad can be connected to a PTZ camera for local control or for control over the network.

See Figure 2 below for the preferred setup. Any PTZ dome camera can be controlled as the DVR is doing the PTZ protocol translation. However, this setup provides only limited dome configuration.

**Figure 2: Connecting a keypad to the TVR 41 for control of a PTZ dome camera over the network**

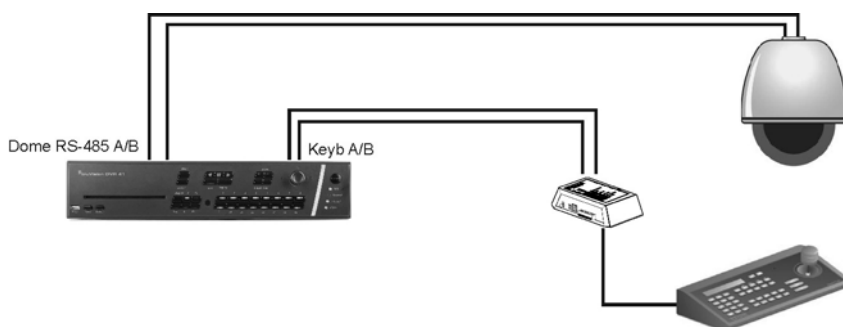

## Configuring the PTZ protocols for Interlogix cameras

Before the PTZ dome cameras are assembled in their housings, set their protocol and address DIP switches for the TVR 41. See Table 2 on page 7 for different Interlogix PTZ dome camera settings.

If you are using PTZ dome cameras from another company, please refer to their configuration instructions.

**Table 2: PTZ protocols for Interlogix cameras**

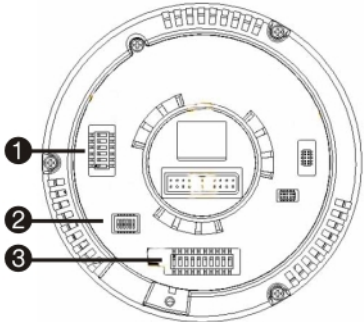
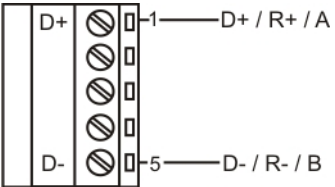
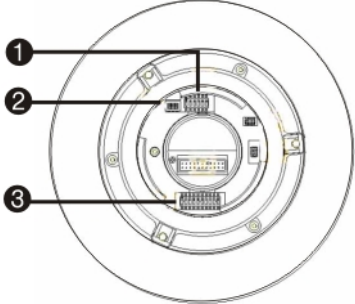
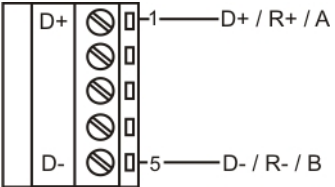
Camera	Switch setting		
TruVision Mini PTZ 12X: Indoor Dome	Protocol DIP switches:	000000	
	RS-485 communication DIP switches:	0000000000	
	Camera ID DIP switches:	Select the camera ID DIP switch address as required	
	RS-485 data connector:		
TruVision Mini PTZ 12X: Outdoor Dome	Protocol DIP switches:	000000	
	RS-485 communication DIP switches:	0000000000	
	Camera ID DIP switches:	Select the camera ID DIP switch address as required.	
	RS-485 data connector:		

1. Protocol DIP switches
2. RS-485 communication DIP switches
3. Camera ID DIP switches

1. Protocol DIP switches
2. RS-485 communication DIP switches
3. Camera ID DIP switches

Camera	Switch setting
TruVision Dome 16X PTZ	Protocol switches: 0111
	Address switches: Select the camera ID DIP switch address as required.
	Baud rate: 0000

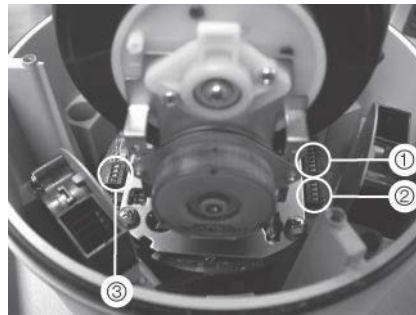

1. Address switches; 2. Baud switches;  
3. Protocol switches

RS-485 data connector:

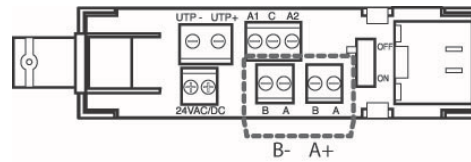

CyberDome	Protocol switches: NA
	Address switches: Select the camera ID DIP switch address as required.

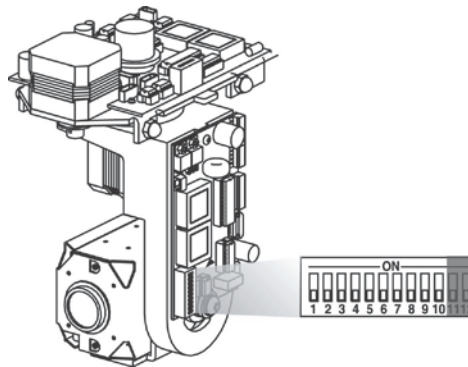

RS-485 data connector:

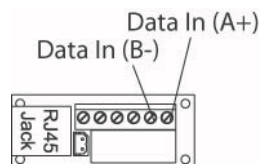

Camera	Switch setting
UltraView PTZ	<p>Protocol switches: 01000</p> <p>Address switches: Select the switch address as required.</p>

1. Protocol switches;  
2. Address switches

RS-485 data connector:

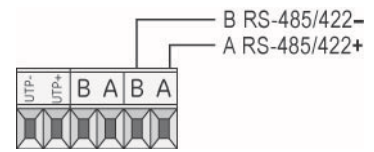

Legend	<p>Protocol switches: 1</p> <p>Address switches: Select the camera ID DIP switch address as required.</p>
--------	---

RS-485 data connector:

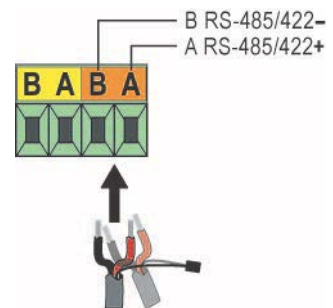

## Wiring the keypad

The keypad uses RS-485 simplex wiring. The signal is transferred by a single twisted pair line. A shielded STP CAT5 network cable is recommended. Ground one end of the cable, either the first or last device on the RS-485 line.

The maximum number of devices that can be installed in one bus is 255, with a maximum cable length of 1200 m. The cable length can be expanded using a signal distributor.

Both the first and the last device in series should be terminated with 120 Ohm resistance to minimize line reflections. See Figure 3 below.

**Figure 3: RS-485 bus serial wiring (KTD-405 keypad shown)**

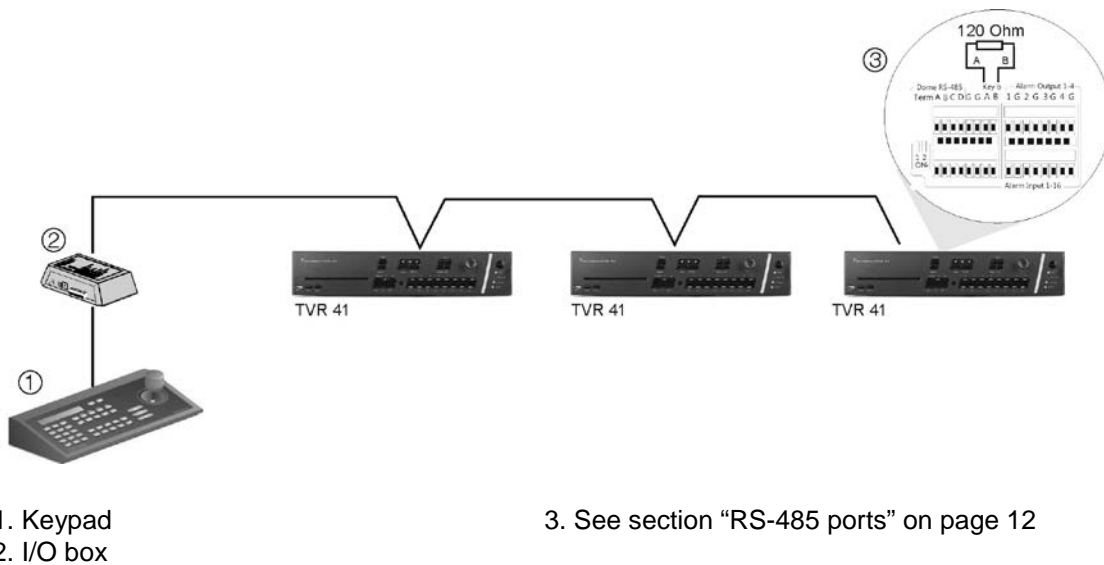

Use an RS-485 signal distributor for a star wiring configuration. See Figure 4 on page 11.



**Figure 4: Star wiring with RS-485 signal distributor**

**Correct:**

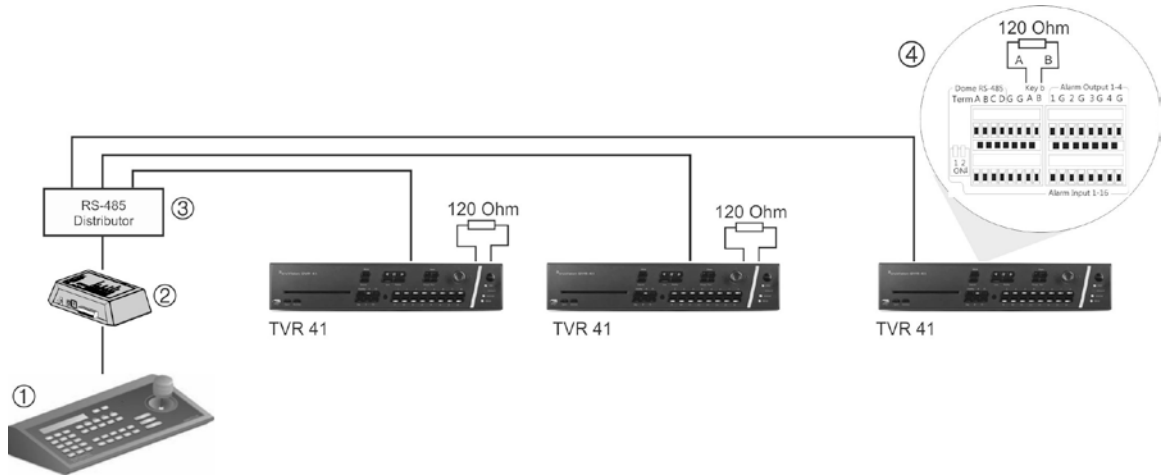

- 1. Keypad
- 2. I/O box

- 3. RS-485 distributor
- 4. See section “RS-485 ports” on page 12

**Incorrect:**

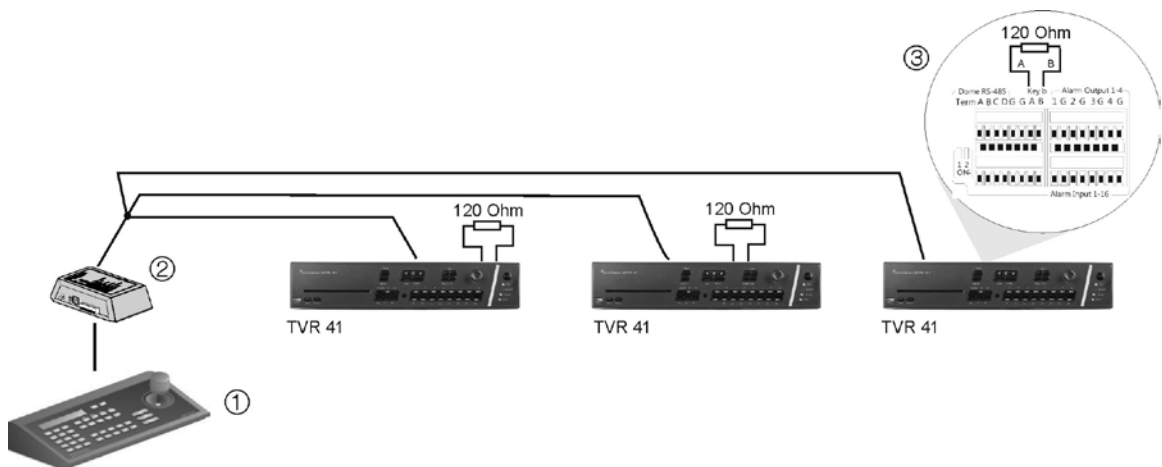

- 1. Keypad
- 2. I/O box

- 3. See section “RS-485 ports” on page 12

Use an **RS-485** signal distributor to increase the maximum number of devices on the bus as well as the total range. Each distributor output provides another RS-485 bus, extending the output an additional 1200 m. Up to 31 TVR 41s can be connected to each output. See Figure 5 on page 12.

**Figure 5: Expanding the system with an RS-485 signal distributor**

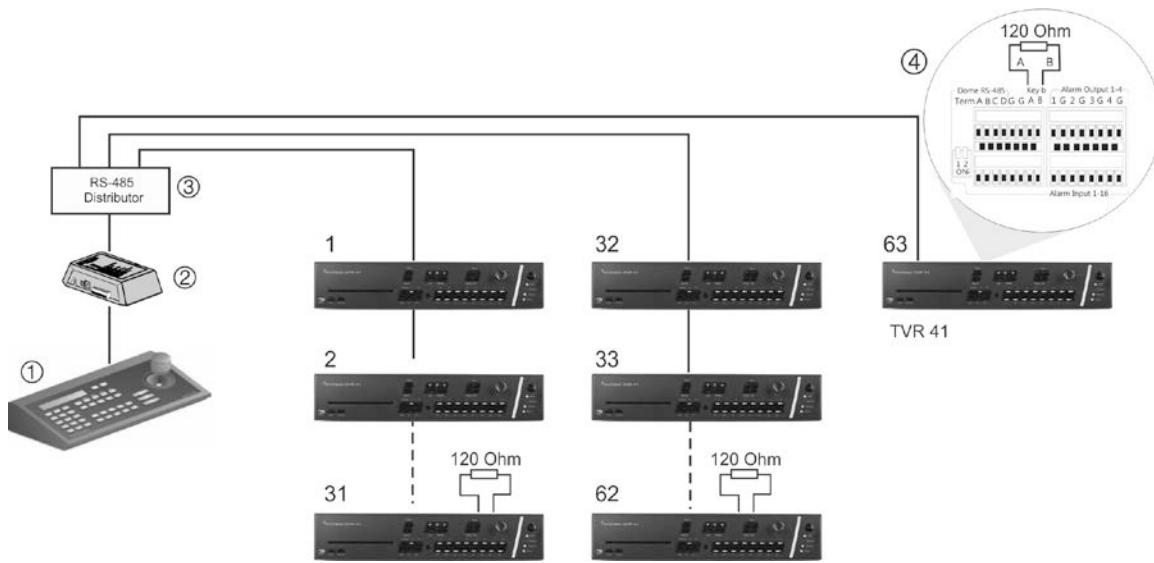

- 1. Keypad
- 2. I/O box

- 3. RS-485 distributor
- 4. See section “RS-485 ports” below

**Caution:** Most signal distributors are unidirectional. This means that the signal only flows from the input towards the outputs. Consequently it is not possible to connect several keypads.

See section “RS-485 ports” below to configure the RS-485 port communication settings.

## RS-485 ports

There are two RS-485 ports on the back panel of the DVR. See Figure 6 on page 13 for the serial pin outs.

- **Dome RS-485:**

A and B: Connect pan, tilt, zoom control of PTZ dome cameras. A = +, B = -

C and D: Not used

G: Ground of dome camera

G: Ground of keypad

- **Keyp:** Connect the keypad.

Figure 6: RS-485 pins

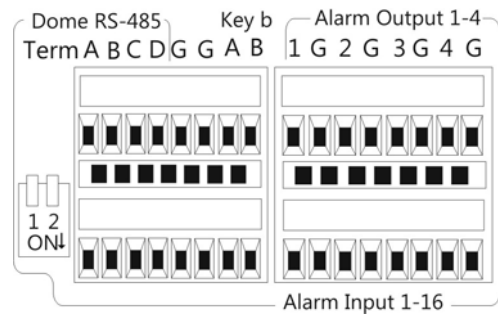

## RS-232 port

Use the RS-232 port to connect CBR-PB3-POS (point-of-sale) and ATM devices to the DVR. See “Configuring the RS-232 port” on page 133 to configure the port.

## Monitor connections

Connect the monitors to the DVR outputs (BNC/VGA/HMDI). The unit provides a 1 Vp-p CVBS signal. See Figure 1 on page 5 for connecting a monitor to a TVR 41.

The TVR 41 supports up to 1280 × 1024 / 60 Hz resolution in VGA. The monitor resolution should be at least 800 × 600. Adjust your monitor accordingly to this resolution.

## Loop through

You can loop through the cameras to equipment such as a matrix, monitors or a second DVR. There are 16 numbered loop-through BNC outputs. See Figure 1 on page 5.

## Audio inputs and output

The unit is equipped with 16 audio inputs and two audio outputs. Both the audio output and the audio inputs are line-level. Each 16 audio input is associated with one of the 16 cameras.

Audio input	RCA jack, 315 mV, 40 kohms. Unbalanced
Audio output	RCA jack, 315mV, 600 ohms. Unbalanced

**Note:** Line-level audio requires amplification.

## Brackets

The DVR is easily rack-mountable with the purchase of the TVR-RK-1 rack-mount kit. See Figure 7 below. Contact your local supplier to order it.

**Figure 7: Rack-mount installation**

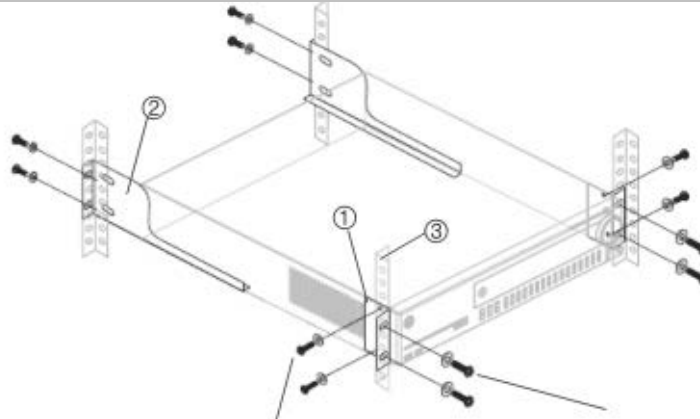

Attach the small front rack ears to the unit  
(screws supplied)

Attach the DVR to the front rails  
(screws not included)

### To install the racks:

1. Attach the two small front-rack mount ears to the DVR (screws supplied).
2. Attach the two large rear support brackets (not supplied) to the rear rails.
3. Attach the DVR to the front rails (screws not supplied).

### Caution:

Do not rack-mount the TVR 41 without the rear rails installed. Failure to install the rear rails can damage the DVR.

# Chapter 3

## Getting started

### Turning on and off the DVR

Before starting the power up process, connect at least one monitor to the video out or the VGA interface. Otherwise, you will not be able to see the user interface and operate the device. Also connect at least one camera.

The DVR auto-detects the video mode (PAL or NTSC) on startup.

It is equipped with a universal power supply that will auto-sense 110/240 V, 60/50 Hz.

**Note:** It is recommended that an uninterruptible power supply (UPS) is used in conjunction with the device.

#### To turn on the DVR:

Turn on the DVR using the power switch on the back panel. A splash screen appears on screen.

Once the TVR 41 is powered up, the indicator bar on the front panel will light up green. All connected cameras are displayed on-screen. The TVR 41 automatically begins recording.

#### To turn off the DVR:

1. In live view mode, right-click the mouse and click **Menu**. The main menu screen appears.
2. Select the **Power Manager** icon.
3. In the Shutdown popup menu, select **Shutdown**. Click **Yes** to confirm shutdown.

#### To reboot the DVR:

1. In live view mode, right-click the mouse and click **Menu**. The main menu screen appears.
2. Select the **Power Manager** icon.
3. In the Shutdown popup menu, select **Reboot**. Click **Yes** to confirm shutdown.

## Using the setup wizard

The TVR 41 has an express installation wizard that lets you easily configure basic DVR settings when first used. It configures all cameras simultaneously. The configuration can then be customized as required.

By default the setup wizard will start once the DVR has loaded. It will walk you through some of the more important settings of your DVR.

Any changes you make to a setup configuration page are saved when you exit the page and return to the main wizard page.

**Note:** If you want to set up the DVR with default settings only, click **Next** in each screen until the end.

### To quickly set up the TVR 41:

1. Connect all the devices required to the back panel of the DVR. See Figure 1 on page 5.
2. Turn on the unit using the power switch on the front panel. After the boot up screen, the DVR displays video images on screen.
3. Select the preferred language for the system from the dropdown list and then click **Next**.
4. Enable or disable the option to start the wizard automatically when the DVR is turned on. Click **Next**.

### 5. Administrator configuration:

Navigate to the Admin Password edit box and click the edit box with the mouse, or press Enter on the front panel or remote control, to display the virtual keyboard. Enter the default admin password, 1234.

**Note:** You must enter an admin password. To change the Admin password, check **New Admin password** and enter the new password and confirm it.

---

**Caution:** It is strongly recommended that you change the password of the administrator. Do not leave 1234 as the default password. Write it down in a safe place so that you do not forget it.

If you should forget the password to your DVR, contact your supplier with the serial number of your DVR to obtain a secure code to reset your DVR.

---

Click **Next**.

### 6. Time and date configuration:

Select the desired time zone, date format, system time and system date.

**Note:** Daylight savings time (DST) cannot be configured from the wizard. See “Configuring time and date” on page 38 for more information on DST.

Time Zone	(GMT-08:00) Pacific Time(U.S. & Canada)
Date Format	MM-DD-YYYY
System Date	09-25-2012
System Time	14:01:47

Apply

Previous    Next    Cancel

**Note:** The system time and date are visible on screen. However, they do not appear in recordings.

Click **Next** to move to the next page, or **Previous** to return to the previous page.

#### 7. **Network configuration:**

Configure your network settings such as the NIC type, IP address, subnet mask and default gateway. Enter the preferred DNS server address as well as the alternate one to use.

NIC Type	10M/100M Self-adaptive
Enable DHCP	<input type="checkbox"/>
IPv4 Address	192.168.1.82
IPv4 Subnet Mask	255 .255 .255 .0
IPv4 Default Gateway	172 .5 .1 .1
Preferred DNS Server	192.0.0.200
Alternate DNS Server	

Previous    Next    Cancel

Click **Next** to move to the next page, or **Previous** to return to the previous page.

#### 8. **HDD management:**

Configure your HDD settings as required.

You can group HDDs and assign cameras to a group. See “Setting up HDD groups” on page 122 for further information. You can also set up a drive for redundant recording. See “HDD redundancy” on page 95.

After configuring your HDD settings, click **Initialize** and **Next** to move to the next page, or **Previous** to return to the previous page.

#### 9. **Recording configuration:**

Configure your recording settings as required. The settings apply to all cameras connected to the DVR.



Check the **Constant Recording** checkbox for the DVR to record continuously all day. If left unchecked, the DVR will not record.

Check the **TL-Hi** check box and select its image resolution and frame rate.

Check the **TL-Lo** check box and select its image resolution and frame rate.

To record motion detection events, check **Event (Motion)** and select the image resolution and frame rate.

To record alarm events, check **Alarm** and select the image resolution and frame rate.

Under **Camera name** enter the camera name. A soft keyboard will appear to enter the characters.

- When all the required changes have been entered, a page appears showing all the settings.



Click **Finish** to exit the Wizard. The TVR 41 is now ready to use.



# Chapter 4

## Operating instructions

### Controlling the TVR 41

There are several ways to control the DVR:

- Front panel control
- Mouse control
- IR remote control
- KTD-405 keypad control (see Appendix)
- Web browser control

You can use your preferred control method for any procedure, but in most cases we describe procedures using mouse terminology. Optional control methods are given only when they differ substantially from mouse control methods.

### Using the front panel

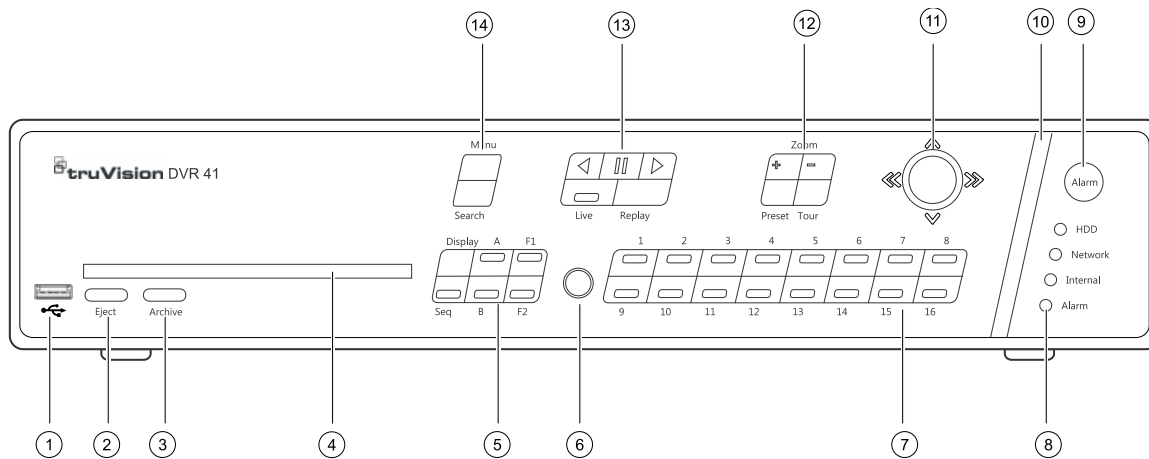

The function buttons on the front panel control can be used to operate many, but not all, of the main functions of the DVR. The LED indicators light up to alert you of various conditions. The functions available can be limited by setting passwords. See Figure 8 on page 20 for more information.

Figure 8: Front panel



The controls on the front panel include:

Item	Name	Description
1.	USB port	Universal serial bus (USB) port for additional devices such as USB mouse and USB hard disk drive (HDD).
2.	Eject button	Ejects CD/DVD disc.
3.	Archive button	Press once to enter quick archive mode. Press twice to start archiving.
4.	CD/DVD slot	Insert a CD or DVD disc.
5.	Display buttons	<b>Display:</b> Toggles through the various multiviews: full, quad, 1+5, 1+7, 9, and 16. <b>Sequence:</b> Starts/stops sequencing in live view mode. <b>A:</b> Selects the main monitor. <b>B:</b> Selects the spot monitor (in live view). <b>F1:</b> In all-day playback, click to start and stop video clipping. <b>F2:</b> In live view mode, click to display/hide the time bar. In all-day playback, click to hide/display the playback control toolbar.
6.	IR receiver	Receiver for IR remote.
7.	Numeric buttons	Switch between different cameras in live, PTZ control or playback modes.
8.	Status LEDs	<b>HDD:</b> Green indicates the DVR is working correctly. Red indicates a fault. <b>Network:</b> Green indicates the network is working correctly. Red indicates a fault or no network connection. <b>Internal:</b> Green indicates the Watchdog is working correctly. Red indicates that the Watchdog is reporting a fault. <b>Alarm:</b> Green indicates no external alarm. Red indicates an external alarm status or motion.
9.	Alarm button	Use to manually acknowledge an alarm.
10.	Alarm indicator bar	Blinking red indicates that there is an alarm.

Item	Name	Description
11.	Joystick	<p>Use to select options in a menu and to control playback. Press for Enter. The LED arrows are lit when the jog is active.</p> <p><b>Live view mode:</b> Press Enter to enter/exit PTZ mode.</p> <p><b>Menu mode:</b> Move the joystick left/right and up/down to position cursor in menu screen. Press for Enter.</p> <p><b>Playback mode:</b> Move the joystick left/right to slow down or speed up playback. Move it up/down to jump forwards or backwards by 30 seconds. Press Enter to stop/start playback.</p> <p><b>PTZ mode:</b></p> <p>Move the joystick to control the movement of the PTZ dome camera. Move the joystick left/right to slow down or speed up PTZ. Move it up/down to jump forwards or backwards by 30 seconds.</p>
12.	PTZ buttons	<p><b>Zoom:</b> Use + and – for digital zoom.</p> <p><b>Preset:</b> Call up preprogrammed preset positions.</p> <p><b>Tour:</b> Call up preprogrammed shadow tours.</p>
13.	Playback buttons	<p> : Jump back to the oldest available video and starts the playback.</p> <p> : Pause playback.</p> <p> : Instantly playback the currently selected file. Default time is 1 minute.</p> <p><b>Live:</b> Switch to live view mode.</p> <p><b>Replay:</b> Replay the current file in playback Starts at the beginning of the file.</p>
14.	Menu and Search buttons	<p><b>Menu:</b> Enter/exit the main menu.</p> <p><b>Search:</b> Enter the advanced search menu.</p>

## Using the mouse

The USB mouse provided with the TVR 41 can be used to operate all the functions of the DVR, unlike the front panel which has limited functionality. The USB mouse lets you navigate and make changes to settings in the user interface.

Connect the mouse to the TVR 41 by plugging the mouse USB connector into the USB port on the back or front panel. The mouse is immediately operational and the pointer should appear.

**Note:** Use a USB 1.1 or higher mouse.

Move the pointer to a command, option, or button on a screen. Click the left mouse button to enter or confirm a selection.

You can purchase a spare mouse by ordering part number TVR-MOUSE-1 TruVision™ DVR Model 40/41/60 Mouse.

See Table 3 below for a description of the mouse buttons.

**Table 3: Mouse buttons**

Item	Description	
Left button	Single-Click	<p><b>Live view:</b> Select a camera to display the quick access toolbar (see “Accessing frequently used commands” on page 34).</p> <p><b>Menu:</b> Select a component of a menu, such as a button or an input field. This is similar to pressing the Enter button on the remote/front panel controls.</p>
	Double-Click	<p><b>Live view:</b> Switch between single screen and multi-screen mode in live/ playback mode.</p>
	Click and Drag	<p><b>Live view:</b> Drag channel/time bar.</p> <p><b>PTZ control:</b> Adjust pan, tilt and zoom.</p> <p><b>Tamperproof, privacy masking and motion detection functions:</b> Select the target area.</p> <p><b>Digital zoom-in:</b> Drag and select target area.</p>
Right button	Single-Click	<p><b>Live view:</b> Display menu.</p> <p><b>Menu:</b> Exit the current menu and return to higher level.</p>
Scroll-wheel	Scroll Up	<p><b>Live view:</b> Return to the previous screen.</p> <p><b>Menu:</b> Move the selection to the previous item.</p>
	Scroll Down	<p><b>Live view:</b> Move to the next screen.</p> <p><b>Menu:</b> Move the selection to the next item.</p>

## Using the IR remote control

The TVR 41 is supplied with an infra red (IR) remote control unit. Like the mouse, it can be used to operate all of the main functions of the TVR 41.

The IR remote control can be programmed with a unique device ID address so that the controller will only be able to communicate with DVRs with that address. No programming is necessary if using a single TVR 41.

The device ID address only applies when using a remote control and not when using a keypad.

You can purchase a remote control by ordering part number TVR-REMOTE-1 TruVision™ DVR Model 40/41/60 IR Remote Control.

Figure 9: IR remote control

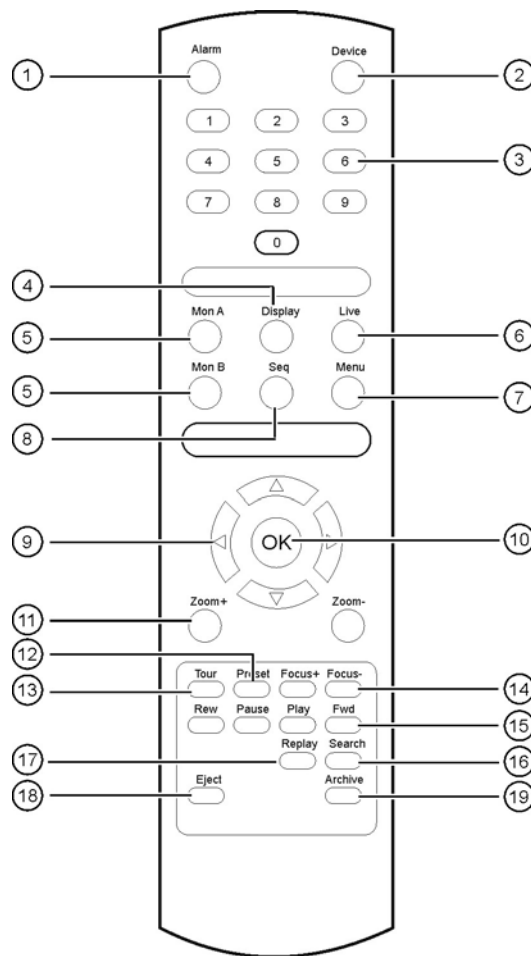

Item	Description
1. Alarm	Acknowledge an alarm.
2. Device	Enable/disable the IR remote control to control the TVR 41.
3. Numeric buttons	Select a camera, and enter a number in a menu option.
4. Display	Switch between the different multiviews.
5. Mon A and Mon B	Switch between monitors A and B.
6. Live	Return to live view mode.
7. Menu	Activate the main menu.
8. Seq	Start /stop sequencing.
9. <, >, ^, v	In Menu mode: Use left or right arrow buttons to select and up or down arrow buttons to edit entry. In PTZ mode: Use to control PTZ. In Playback mode: Use to control playback speed.
10. OK	Confirm selection.
11. Zoom + and -	Use to control zoom of camera lens.
12. Preset	Enter preprogrammed three-digit code to call up a preset.
13. Tour	Enter preprogrammed three-digit code to call up shadow tour.

<b>Item</b>	<b>Description</b>
14. Focus + and -	Use to control focus of camera lens.
15. Playback control	Use to control playback (Rewind, Pause, Play, and Fast Forward).
16. Search	Open the Search menu.
17. Replay	Replay the selected file from the beginning.
18. Eject	Eject the CD or DVD disk.
19. Archive	Press once to enter quick archive mode. Press twice to start archiving.

Aim the remote control at the IR receiver located at the front of the unit to test operation.

#### **To connect the remote control to the TVR 41:**

1. Press the **Menu** button on the front panel or right-click the mouse and select the **Menu** button. The main menu screen appears.
2. Click **Display Mode Settings > Monitor**.
3. Check the device address value. The default value is 255. This device address is valid for all IR controls.
4. On the remote control press the **Device** button.
5. Enter the device address value. It must be the same as that on the TVR 41.
6. Press **OK** on the remote control.

#### **To place batteries into the IR remote control:**

1. Remove the battery cover.
2. Insert the batteries. Make sure that the positive (+) and negative (-) poles are correctly placed.
3. Replace the battery cover.

#### **Troubleshooting the remote control:**

If the IR remote control is not functioning properly, perform the following tests:

- Check the battery polarity.
- Check the remaining charge in the batteries.
- Check that the IR remote control sensor is not masked.

If the problem still exists, please contact your administrator.

## Menu overview

The TVR 41 has an icon-driven menu structure that allows you to configure the unit's parameters. Each command icon displays a dialog screen that lets you edit a group of settings. Most menus are available only to system administrators.

The configuration screen is divided into three sections. The currently selected command icon and submenu item are highlighted in green. See Figure 10 below.



You must be in live view to access the main menu.

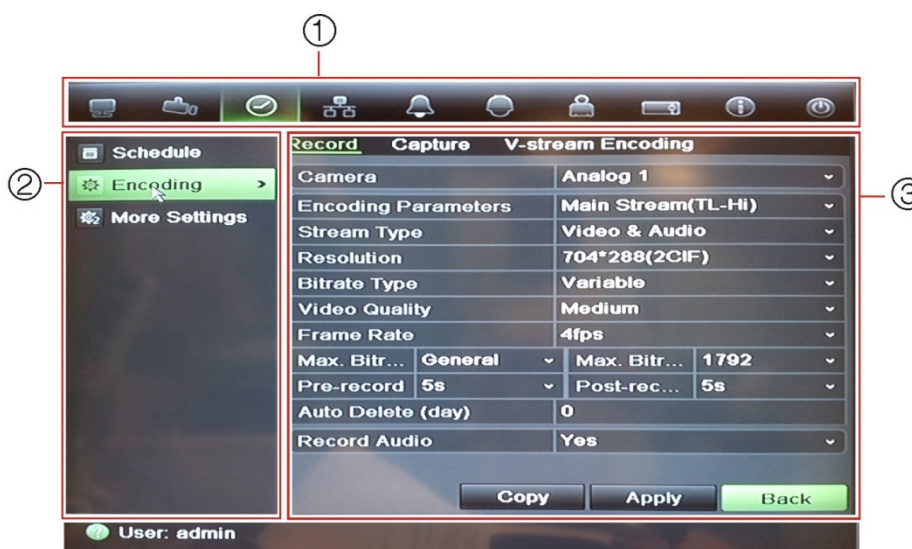





Figure 10: Menu structure



1. **Menu toolbar:** Setup options available for the selected configuration menu function. Move the mouse over a command icon and click to select it. See Table 4 below for a description of the icons.
2. **Submenu panel:** Submenus for the selected menu function are displayed. Click an item to select it.
3. **Setup menu:** All the details for the selected submenu are displayed. Click a field to make changes.

Table 4: Description of the menu toolbar icons

Icon	Name	Description
	Display mode settings	Configures display settings including dwell time, schedule, language and display formats. See "Configuring live view" on page 35 and "Holiday schedules" on page 92.
	Camera management	Configures camera settings including <a href="#">OSD display</a> , motion detection, video image adjustments, and copy settings to other cameras. See Chapter 14 "Camera settings" on page 129.
	Video schedule	Configures recording settings including recording schedules, record quality, auto delete mode, and recording mode. See Chapter 10 "Recording" on page 87.

Icon	Name	Description
	Network settings	Configures standard network settings including IP address, e-mail notifications, DDNS setup, and advanced network settings. See Chapter 12 "Network settings" on page 109.
	Alarm settings	Configures alarm settings including alarm input, relay output, video loss, remote alert, pre-alarm and post-alarm seconds. See Chapter 11 "Alarm settings" on page 97.
	PTZ settings	Configures PTZ settings. See Chapter 6 "Controlling a PTZ camera" on page 43.
	User management	Configures users, passwords, and access privileges. See Chapter 16 "User management" on page 139.
	System settings	Configures system settings including system date and time, audio output, device name, RS-485 settings, RS-232 settings, firmware upgrade, hard drive settings, boot log, and shutdown. See Chapter 13 "HDD management" on page 121 and Chapter 15 "DVR management" on page 133.
	Help information	Provides reference information to the various toolbars, menus, and keys within the interface.
	Power manager	Provides access to logout, reboot and shutdown options. See "Turning on and off the DVR" on page 15.

### To access the main menu:

1. In live view, press the **Menu** button on the remote control or front panel.  
- Or -  
Right-click the mouse and select **Menu** from the pop-up menu.  
The main menu screen appears. The Display screen appears by default.
2. Click the required menu icon to display its submenu options. Modify the configuration parameters as required.
3. Click **Apply** to save the settings.
4. Click **Back** to return to live view.

## Using the soft keyboard

A keyboard will appear on-screen when you need to enter characters in a screen option. Click a key to input that character.



Figure 11: The soft keyboard



Description of the keys in the virtual keyboard:

	Switch to lowercase/uppercase
	Space
	Exit the soft keyboard
	Alphanumeric characters
	Backspace
	Symbols
	Confirm selection

## Exiting the main menu

Press the **Menu** button on the front panel to exit the current menu screen and return to live view or click **Back** in a main menu.



# Chapter 5

## Live view





### Description of live view

Live view is the normal operating mode of the unit where you watch live images from the cameras. The TVR 41 automatically enters into live view once powered up. On the viewer, you can see the current date and time, camera name, and whether a recording is in progress.

### Status information

Information on the system and camera status is displayed as icons on the main and spot monitors. The camera status icons are shown for each camera. Each icon represents information on a specific item. These icons include:

**Table 5: Description of the on-screen status icons**

Icon	Description
	Indicates a sensor alarm.
	Indicates recording (such as manual recording, motion detection or alarm-triggered recording).
	Indicates a motion detection event.
 Video Loss	Indicates a video loss event.
	Indicates alarm and system notifications. Clicking the icon opens a screen that lists the alarms and notifications.

More than one icon can be displayed at the same time.

The system status is displayed on the front panel by the status LEDs.

### Video output

The TVR 41 can be connected to up to two monitors. However, only one monitor can be controlled at a time.

The DVR automatically checks the monitor outputs used. If more than one monitor is connected, it then defines which monitor is the main one and which is the auxiliary. The priority level for main and spot outputs is HDMI > VGA > CVBS. See Table 6 below.

**Table 6: Monitor output priority level**

Monitor output in use			Priority level	
HDMI	VGA	CVBS	Main monitor	Spot monitor
X		X	HDMI	CVBS
	X	X	VGA	CVBS
		X	CVBS	

#### To select the video output of the main monitor:

1. Click the **Display Mode Settings** icon in the menu toolbar.
2. Select **Layout > General**.
3. From **Video Output Interface**, select which monitor will be the main monitor: HDMI (depends on DVR model), VGA, main CVBS, or spot output. VGA is default, if connected.

#### To control a monitor:

On the front panel, press button A to select the main monitor. Press button B to select the spot monitor.

## Audio output

The HDMI monitor connector on the back panel outputs both video and audio signals. There are audio outputs on the back panel for speakers.

## Controlling live view

Many features of the live view can be quickly accessed by placing the cursor on a live image and clicking the right-button of the mouse. The mouse menu appears (see Figure 12 on page 31).

Figure 12: The mouse menu for the main monitor

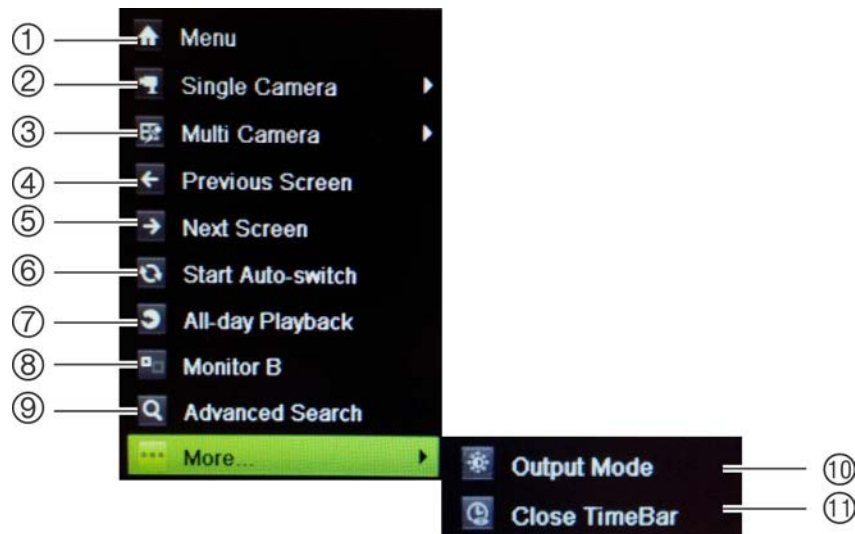

The list of commands available depends on which monitor is active; main or spot (monitor B). See Table 7 below. The default settings of these commands are provided in Appendix G, “Default menu settings” on page 165.

Table 7: Mouse menu for monitor A (main monitor)

Item	Name	Description
1.	Menu	Enter the Main menu. This option is not available from monitor B.
2.	Single camera	Switch to a full-screen view for the selected camera from the dropdown list.
3.	Multi camera	Switch between the different multiview options from the dropdown list.
4.	Previous screen	Display the previous camera.
5.	Next screen	Display the next camera.
6.	Start auto-switch	Turn on sequence mode. The screen automatically sequences between cameras. See “Viewing in multiview” on page 32. Go to Menu > Display Mode Settings > Layout > General > Dwell Time to set up.
7.	All-day playback	Playback the recorded video of the selected day from the selected camera. The current day is selected by default. See “All-day playback” on page 55 for more information.
8.	Monitor B	Switch between monitors A (main) and B (spot).
9.	Advanced search	Enter the advanced video search menu. See “Searching recorded video” on page 56 for more information.
10.	Output mode	Select desired output mode: Standard, bright, soft, and vivid.
11.	Close timebar	Open/close the time bar.

**Note:** When the monitor B is active, the main monitor commands are unavailable.

**Table 8: Mouse menu for monitor B (spot monitor)**

Item	Name	Description
1.	Single camera	Switch to a full-screen view for the selected camera from the dropdown list.
2.	Multi camera	Switch between the different multiview options from the dropdown list.
3.	Previous screen	Displays the previous camera.
4.	Next Screen	Displays the next camera.
5.	All-day playback	Playback the recorded video of the selected day from selected cameras. See “All-day playback” on page 55 for more information.
6.	Monitor A	Switch between monitors A (main) and B (spot).

## Multiview format

The DVR has full screen display format as well as five multiview formats.

### Viewing in full screen

Press the numeric button on the front panel to switch to the corresponding camera display. For example, press button 10 to view camera 10.

Right-click the mouse and select **Single Camera** from the menu. Select the camera required from the list.

### Viewing in multiview

A video tile is any cell in a multiview display. A camera image can only be shown in one video tile at a time. The TVR 41 has five multiview display formats available as well as full screen. See Figure 13 below.

To change the multiview display that appears by default, go to the Display menu. See “Changing the camera sequence” on page 37 for more information.

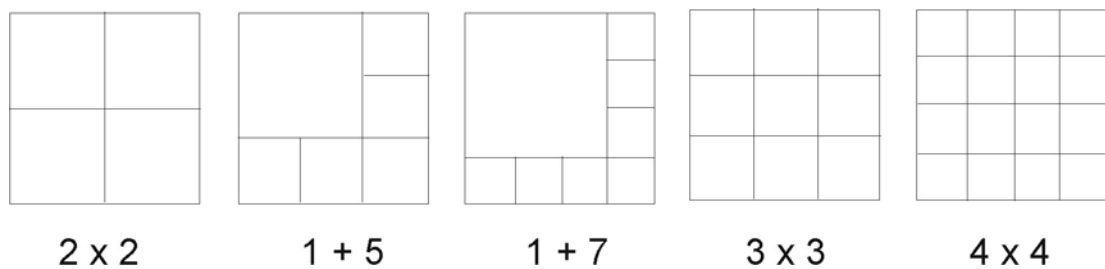
**Figure 13: Multiview display formats****To select a multiview format:**

1. Press the Display button on the front panel to cycle through different display formats.

You can also right-click the mouse and select **Multi Camera** from the menu. Select the desired multiview display layout.

## Sequencing cameras

The sequencing feature allows a camera to be displayed briefly on screen, before advancing to the next camera in the sequence list. Sequencing can only be done in full screen mode.

The default sequence displays each camera in numerical order. However, each camera on the main and spot monitors can have a pre-programmed dwell time and sequence order. See “Changing the camera sequence” on page 37 for more information.

**Note:** Dwell time must not be set to zero for sequencing to function.

**Sequencing live view mode using the front panel:**

1. Select the camera where you want to start sequencing.
2. Press the **Seq** button on the front panel to start sequencing.
3. Press the **Seq** button again to stop the sequencing.

**Sequencing live view mode using the mouse:**

1. Select the camera where you want to start sequencing.
2. Right-click the mouse and select **Start auto-switch** to start the sequencing.
3. Right-click the mouse and select **Stop auto-switch** to stop the sequencing.

## Accessing frequently used commands

The quick access toolbar in live view lets you quickly access regularly used commands. Position the cursor over a video image and left-click the mouse. The toolbar appears (see Figure 14 below).



Figure 14: Quick access toolbar



Table 9: Description of the quick access toolbar icons

Icon	Description
	<b>Freeze:</b> Freeze the live image of the selected camera. Although the image pauses, time and date information does not. The system clock continues to run.
	<b>Manual record:</b> Start/stop manual recording. The icon is red when manual recording is enabled. See “Manual recording” on page 93 for information on setting up this function.
	<b>Instant playback:</b> Play back the recorded video from the last five minutes (default time). If no recording is found, then there was no recording made. Click the icon and select the desired camera. Click OK. See “Instant playback” on page 54 for information on changing this time.
	<b>Audio:</b> Enable/Disable audio output. The audio option must already have been setup in the Display menu.
	<b>Quick snapshot:</b> Capture a snapshot of a video image. The image is saved on the unit.
	<b>PTZ control:</b> Enter PTZ control mode.
	<b>Digital zoom:</b> Enter digital zoom. See “Digital zoom” below for further information.
	<b>Image settings:</b> Enter the image settings menu to modify the image lighting levels. There are <b>three</b> options: <b>Preset Mode:</b> These are preconfigured image lighting levels. Select one of the four options depending on current lighting conditions: <ul style="list-style-type: none"> <li>- <i>Standard:</i> Use in standard lighting situations.</li> <li>- <i>Indoor:</i> Use indoors.</li> <li>- <i>Dim Light:</i> Use when the light level is low.</li> <li>- <i>Outdoor:</i> Use when outdoors. The contrast and saturation values are high.</li> </ul> <b>Customize:</b> Modify brightness, contrast, saturation, and hue values. <b>Restore:</b> Restore image settings to previous values. These settings can also be modified from the Camera>Image menu (see page “Adjusting camera image settings” on page 131).



Icon	Description
	<b>Text show:</b> Display inserted text on screen. Color of the text can be changed: Black, white, or pink.
	<b>Close toolbar:</b> Close the shortcut toolbar.

## Digital zoom

You can easily zoom in or out of a camera image in live view and play back using the digital zoom command. The zoom command magnifies the camera image four times. See Figure 15 on page 35.

**Figure 15: Digital zoom screen**



### To quickly zoom in/out on a camera image:

1. Select the camera you wish to use.
2. Left-click the mouse and select the digital zoom icon, or on the front panel press the **Zoom+** button. The digital view screen appears.
3. Left-click the mouse and drag the red square to the area of interest, or move the joystick on the front panel to position the red square. The selected area is magnified.
4. To exit digital zoom right-click the mouse or press the **Zoom—** button on the front panel.

## Configuring live view

The setup of live view can be modified from the main menu to suit different needs, such as the different monitors, multiview layout, and dwell time options. You can also enable audio output.

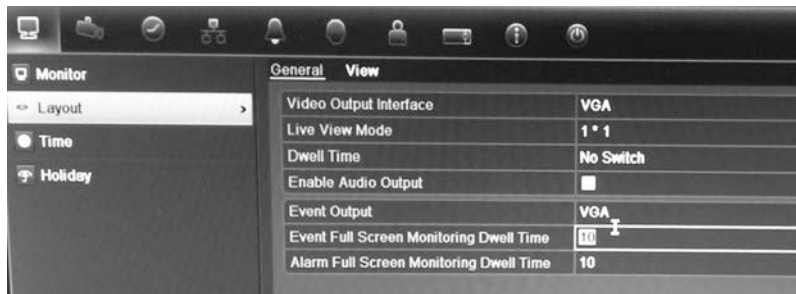
**Figure 16: Layout screen****Table 10: Description of the layout screen**

Submenu name	Description
<b>General tab</b>	
Video output interface	Select which monitor will be the main monitor: HDMI (depends on DVR model), VGA, main CVBS or spot output. Default is VGA, if connected.
Live view mode	Select which multiview layout will be default in live view mode. Default is 4x4 multiview layout.
Dwell time	Set the length of time for which a camera image is displayed on the selected monitor before moving to the next camera during sequencing. Default is off ("No switch").
Enable audio output	You can hear audio from cameras in both live and playback mode. However, in order to be able to hear audio in playback you must enable the audio output setting. Check the box to enable/disable audio output.
Event output	Select which monitor will be the spot monitor. Default is the spot monitor (Spot output 1).
Event full screen monitoring dwell time	Set the length of time for which a camera that has an event or alarm appears on the selected monitor before moving to the next camera during sequencing. Default is 10 seconds.
Alarm full screen monitoring dwell time	Set the length of time for which a camera that has an alarm appears on the selected monitor before moving to the next camera during sequencing. Default is 10 seconds.

**To set up the display options:**

1. Click the **Display Mode Settings** icon in the menu toolbar.
2. Select **Layout > General**.
3. Specify the desired settings for each of the menu options.
4. Click **Apply** to save the settings.
5. Click **Back** to return to live view.

## Changing the camera sequence

The cameras are sequenced in numeric order by default. You can change the sequence order of the cameras for all monitors.

You can switch the channel of a camera with that of another camera in the system. This lets you, for example, have the images of camera 1 appear on channel 10, and the images of camera 10 appear on channel 1. This feature is useful when you want to watch the sequence of images from specific cameras so that they are next to each other on-screen.

See Figure 17 below. Each video tile displays both the order of the camera in the sequence and the camera number.

Figure 17: Camera layout and sequence screen

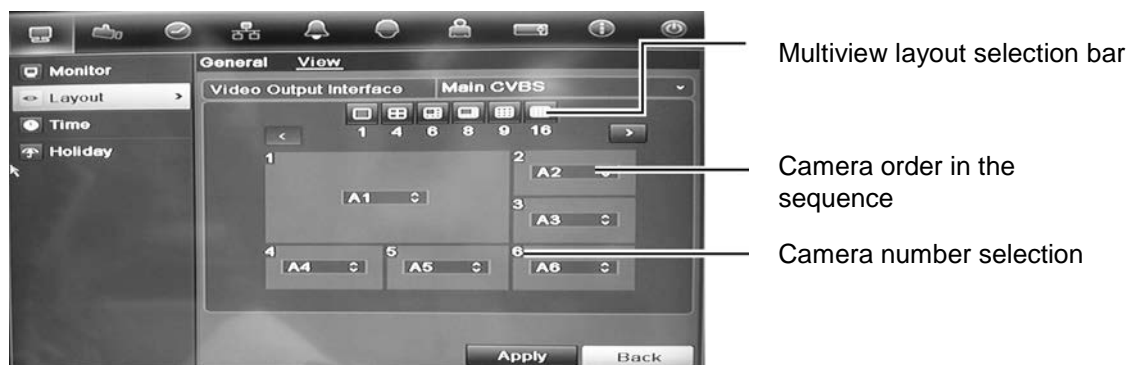

### To set the camera sequencing:

1. Click the **Display Mode Settings** icon in the menu toolbar.
2. Select **Layout > View**.
3. From **Video Output Interface**, select the desired monitor from the drop-down list.
4. From the multiview layout selection bar, select the desired multiview layout.
5. Select the video tile of the camera whose order you want to change. The selected tile is highlighted green.
6. In the selected tile, select the new camera sequence order by scrolling the through the list of available camera numbers.

**Note:** "X" means that the camera is not displayed.

7. Click **Apply** to save the settings.
8. Click **Back** to return to live view.

## Camera sequencing for alarms and events

You can select which monitor is used to sequence alarm and event cameras in full screen mode. Normally this is the spot monitor. When an alarm or event occurs, the selected monitor will sequence through the alarm/event cameras

depending on the dwell time set up. You can set up different dwell time for alarms and events.

### To set the camera sequencing for alarms and events:

1. Click the **Display Mode Settings** icon in the menu toolbar.
2. Select **Layout > General**.
3. From **Event Output**, select the desired monitor from the drop-down list. Default is VGA, if connected
4. Select the dwell times for the alarm and event cameras. Default is 10 seconds. The dwell time can range between 10 and 300 seconds.
5. Click **Apply**.

## Configuring time and date

You can set up the date and time that will appear on-screen. It is not included in recordings. This time and date display is separate from the embedded one that appears for each camera (see “Configuring the camera OSD settings” on page 129 for more information on embedded camera time and date).

The start and end time of daylight savings time (DST) in the year can also be set. DST is deactivated by default. See Figure 18 below for the Time settings screen.

Figure 18: Time and date settings screen



**Table 11: Description of the time and date settings screen**

Option	Description
Time zone	Select the time zone of the DVR from the drop-down list.
Date format	Select the date format from the drop-down list. Default format is DD-MM-YYYY.
Time format	Select the time format from the drop-down list. Default format is 24-hour format.
Display week	Display the day of the week in the monitor time bar. Check the box to enable/disable. Default format is Disable.
System date	Define the system date. Default date is the current date.
System time	Define the system time. Default time is the current time.
Auto DST adjustment	Define DST is automatically. It depends on the time zone selected. Default format is Disable
Enable DST	Manually define DST. If this option is selected, the Auto DST adjustment option is disabled. Default format is Disable. Click the check box to enable or disable daylight savings time (DST).
From	Enter the start date and time for daylight savings.
To	Enter the end date and time for daylight savings.
DST bias	Set the amount of time to move DST forward from the standard time. Default is 60 minutes.

### To set up the system time and date:

1. Click the **Display Mode Settings** icon in the menu toolbar.
2. Select **Time**. Modify the required settings.
3. Click the **Apply** button to immediately implement the changes.

## General settings

Use the Display mode settings menu to configure general DVR options on how information is displayed and accessed such as:

- Change GUI language
- Change the DVR name and address
- Define the monitor resolution
- Enable/disable the login password requirement
- Enable/disable the wizard

- Manually change the video output format (PAL/NTSC)
- Change the time out period after which the display reverts to showing live view
- Enable/disable the transparency of the menus on screen
- Enable/disable whether the status icons appear on screen

See Figure 19 below and Figure 20 on page 41.

The changes are immediately implemented once Apply is clicked to save the settings.

**Figure 19: Monitor setup screen: General Settings**



**Table 12: Description of the Monitor setup screen: General Settings**

Option	Description
Language	Change the language of the system. Select the desired language from the drop-down list and click <b>Apply</b> . The language displayed changes immediately.
Device name	Define the DVR name. The default name is TVR 41. Click the edit box and enter the new name from the soft keyboard.
Device address	The device number to use for the DVR when programming the remote control. The default value is 255.
Zone ID	Each DVR in a daisy chain must have a unique zone ID so that it can be controlled by a KTD-405 keypad. The default value is 1.
VGA resolution	Define the VGA resolution. Select one of the options from the drop-down list and click <b>Apply</b> . The selected resolution must be the same as that of the monitor.
HDMI resolution	Define the HDMI resolution. Select one of the options from the drop-down list and click <b>Apply</b> . The selected resolution must be the same as that of the monitor.
Password required	Define whether a login password is required. Check the box to enable/disable and click <b>Apply</b> .
Scaling output video	Enable/disable the monitor display of the main and spot monitor size to accommodate for differently sized monitors. Check the box to enable/disable and click <b>Apply</b> .

Option	Description
Enable wizard	Define whether the wizard tool starts when the DVR is turned on. Check the box to enable/disable and click <b>Apply</b> .

**Figure 20: Monitor setup screen: More Settings**



**Table 13: Description of the Monitor setup screen: More Settings**

Option	Description
Monitor standard	The video standard used is auto detected but can be manually changed. Modify the video standard used to PAL or NTSC and click <b>Apply</b> .
Output mode	Define the desired output mode. Select one of the options from the drop-down list: Standard, Bright, Gentle, or Vivid.
Monitor brightness	Modify the video output brightness. Adjust the scroll bar point to the desired level and click <b>Apply</b> .
Event hint	Define whether the status icons appear on screen. See “Status information” on page 29 for more information.
Timebar transparent	Modify the transparency of the menus on-screen relative to the background to make the menu screens easier to read or less prominent on-screen. Default is non-transparent. Select one of the options from the drop-down list.
Menu timeout	Define the time in minutes after which the menu screen reverts to live view mode. Select a time from the drop-down list and click <b>Apply</b> .
Mouse pointer speed	Modify the speed of the mouse pointer. Adjust the scroll bar point to the desired level and click <b>Apply</b> .
Other notification: Panel alarm LED	Check to enable the Motion alarm option.
Motion alarm	Define whether the status LEDs on the front panel start flashing when motion is detected. Check the box to enable/disable and click <b>Apply</b> .

## V-stream encoding

If the available bandwidth is limited you can remotely view several channels in real time with one stream over the web browser or CMS (Client Management System), such as TruVision navigator, using the V-stream encoding option (“V” stands for “virtual”). When enabled, you can see the output from the cameras on a CVBS spot monitor in one stream.

**Note:** It is not recommended to use the V-stream feature when using a CVBS monitor as main monitor as both the CVBS main monitor and the V-stream use the same output.

### To enable v-streaming:

1. Click the **Video Schedule** icon in the menu toolbar.
2. Select **Encoding > V-stream Encoding**.
3. Check **Enable V-stream Encoding**.
4. Select the desired settings for frame rate, and maximum bit rate (Kbps).
5. Click **Apply** to save the settings.



# Chapter 6

## Controlling a PTZ camera

You can control PTZ dome cameras using the buttons on the front panel, the keypad, and IR remote control as well as using the PTZ control panel accessed with the mouse. Access to PTZ commands may require a password.

A detailed list of the PTZ commands available for many different camera protocols is available in Appendix F on page 165.

### Configuring PTZ settings

Use the **PTZ Settings** menu to configure the PTZ dome cameras. Each camera must be set up individually. Cameras must be configured before they can be used.

Ensure that the PTZ dome cameras are correctly connected to the RS-485 port on the back panel.

**Note:** If a camera does not work correctly after configuring the DVR, check the parameters entered.

#### To configure PTZ dome camera settings:

1. Click the **PTZ Settings** icon in the menu toolbar.
2. Click **General** and select the PTZ dome camera to be configured from the drop-down camera list.
3. Select the baud rate, data bit, stop bit, parity, flow control, PTZ protocol and address for the camera. See Appendix G, “Default menu settings”, on page 165 for the default values.

**Note:** It is important to ensure that the settings correspond with those used in the PTZ camera.

4. Click **Copy** to copy the settings to another camera, if required.
5. Click **Apply** to save the settings.

## Calling up presets, tours and shadow tours

When in live view you can quickly call up the list of existing presets, preset tours and shadow tours by using the front panel, remote control, mouse and keypad.

Front panel	Press the joystick to Enter. PTZ control panel appears.
Mouse	Right-click the mouse on the desired camera image. The quick access toolbar appears. Click the PTZ control icon to enter PTZ mode. The PTZ control panel appears.
Remote control	Press the OK button. The PTZ control panel appears.
Keypad	Press the Enter ↵ button on the keypad. For further information, see Appendix D “KTD-405 keypad” on page 155.

If the display was in multiview format, it changes to full screen format for the selected camera. See Figure 21 below for a description of the PTZ control panel.

Figure 21: PTZ control panel

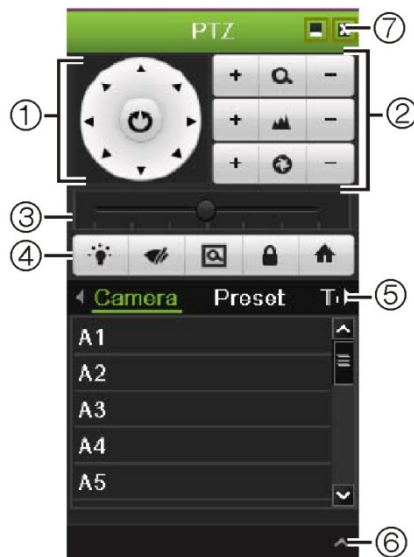

Table 14: Description of the PTZ control panel

Item	Name	Description
1.	Directional pad/auto-scan buttons	Controls the movements and directions of the PTZ. Center button is used to start auto-pan by the PTZ dome camera.
2.	Zoom, focus and iris	Adjusts zoom, focus and iris.
3.	PTZ movement	Adjusts the speed of PTZ movement.
4.	Toolbar	Turns on/off camera light.
		Turns on/off camera wiper.
		Zoom area.
		Centers the PTZ dome camera image. This command is not supported on all PTZ dome cameras.
		Jumps to the home position.

Item	Name	Description
5.	Select PTZ command	Displays the desired function from the scroll bar: camera, preset, preset tour or shadow tour.
6.	Open/close menu	Opens/closes the PTZ command section of the PTZ control panel.
7.	Exit	Exits the PTZ control panel.

## Setting and calling up presets





Presets are previously defined locations of a PTZ dome camera. It allows you to quickly move the PTZ dome camera to a desired position. They are configured and modified from the PTZ configuration window (see Figure 22 below).

**Note:** The PTZ dome camera used must be able to support a preset command. See Appendix F on page 165 for the complete list of PTZ commands available by camera protocol.

Figure 22: PTZ configuration window



Table 15: Description of the PTZ configuration window

Item	Name	Description
1.	Save preset	Saves preset.
2.	Call preset	Calls up pre-existing preset.
3.	Shadow tour toolbar	 Starts recording the shadow tour.
		 Saves the shadow tour.
		 Starts the selected shadow tour.
		 Deletes the selected shadow tour.

Item	Name	Description
4.	Preset tour toolbar	 Adds a step to a selected preset tour.
		 Starts the selected preset tour.
		 Stops the selected preset tour.
		 Deletes all the preset tour steps.
		 Scroll up the list.
		 Scroll down the list.

### To set up a preset:

1. Click the **PTZ Settings** icon on the menu toolbar and select **More Settings**.
2. Use the directional, zoom, focus and iris buttons to position the camera in the desired preset location.
3. Check **Save Preset** and enter a preset number. The preset is enabled and stored in the camera.

If the desired preset number is larger than the 17 numbers listed, click [...]. The Preset screen appears. Select a preset number from the dropdown list and click the **OK** button to save changes.

**Note:** Presets can be overwritten.

4. Click **Back** to return to live view.

### To call up a preset:

- **PTZ control panel:**

1. In live view left-click the mouse and select the PTZ control icon in the quick access toolbar. The PTZ control panel appears. Select the desired camera from the toolbar.

– Or –

On the front panel, select the desired camera and press **Enter** on the joystick to call up the quick access toolbar. The PTZ control panel appears.

2. Scroll the toolbar to **Preset** and double-click the desired preset from the list. The camera immediately jumps to the preset position.

- **Menu toolbar:**

1. Click the **PTZ Settings** icon on the menu toolbar and select **More Settings**. The PTZ configuration window appears.
2. Check **Call Preset** and enter the preset number to call up. The camera immediately moves to that preset position.
3. Click **Back** to return to live view.

## Setting and calling up preset tours

Preset tours move a PTZ dome camera to different steps (called “Keypoint” in the interface). The camera stays at a step for a set dwell time before moving on to the next step. The steps are defined by presets (see “Setting and calling up presets” on page 45.)

Each preset tour consists of steps. A step consists of a step number, a dwell time, and a speed.

The step number is the order the camera will follow while cycling through the preset tour. The dwell time is the length of time for which a camera stays at a step before moving to the next one. The speed is the rate at which the camera will move from one key point to the next.

**Note:** The PTZ dome camera used must be able to support a preset tour command. See Appendix F on page 165 for the complete list of PTZ commands available by camera protocol.

### To set up a preset tour:

1. Click the **PTZ Settings** icon on the menu toolbar and select **More Settings**.
2. Select the preset tour number.
3. In the preset tour toolbar, click  to add a step to the preset tour. The Keypoint window appears. Select the preset number, dwell time and speed of the step. Click **OK** to save the settings.



**Note:** A preset tour should have at least two presets.

4. Repeat step 3 to configure other steps (“Keypoints”) in the preset tour.



5. In the preset tour toolbar, click  to call up the preset tour.
6. Click **Back** to return to live view.

**To delete a preset tour:**

1. Click the **PTZ Settings** icon on the menu toolbar and select **More Settings**.
2. From the preset list, select a tour number and click  to delete the selected preset tour.

– Or –

In the preset tour toolbar, click  to delete all the preset tours.

3. Click **Back** to return to live view.

**To call up a preset tour:**

- **PTZ control panel:**



1. In live view left-click the mouse and select the PTZ control icon in the quick access toolbar. The PTZ control panel appears. Select the desired camera from the toolbar.

– Or –

On the front panel, select the desired camera and press **Enter** on the joystick to call up the quick access toolbar. The PTZ control panel appears.

2. Scroll the toolbar to **Tour** and double-click the desired preset tour from the list. The camera immediately carries out the preset tour movement.

- **Menu toolbar:**



1. Click the **PTZ Settings** icon on the menu toolbar and select **More Settings**.
2. Select the desired preset tour from the list and click  to start the tour. Click  to stop the preset tour.
3. Click **Back** to return to live view.

## Setting and calling up a shadow tour

The shadow tour command remembers the manually-controlled PTZ dome camera movement track. One shadow tour can be set up.

**Note:** The PTZ dome camera used must be able to support a shadow tour command. See Appendix F on page 165 for the complete list of PTZ commands available by camera protocol.

**To set up a shadow tour:**

1. Click the **PTZ Settings** icon on the menu toolbar and select **More Settings**.
2. Select the shadow tour from the list.
3. To record a new shadow tour, click  and use the directional buttons on the PTZ control panel to move the camera along the desired path.
4. Click  to save the shadow tour.

**Note:** The shadow tour can be overwritten.

5. Click **Back** to return to live view.

**To call up a shadow tour:**

- **PTZ control panel:**



1. In live view left-click the mouse and select the PTZ Control icon in the quick access toolbar. The PTZ control panel appears. Select the desired camera from the toolbar.

– Or –

On the front panel, select the desired camera and press **Enter** on the joystick to call up the quick access toolbar. The PTZ control panel appears.

2. Scroll the toolbar to **Shadow Tour** and double-click the shadow tour from the list. The camera immediately carries out the shadow tour movement.

- **Menu toolbar:**

1. Click the **PTZ Settings** icon on the menu toolbar and select **More Settings**.
2. Select the shadow tour from the list and click  to start the tour. Click  to stop the shadow tour.
3. Click **Back** to return to live view.





# Chapter 7

## Playing back a recording

The TVR 41 lets you to quickly locate and play back recorded video. There are four ways to play back video:

- Instant playback of the most recently recorded video
- All-day playback of the day's recorded video
- Search the video archives by specific time, date, bookmark, snapshot, or event
- Search the system log

The DVR continues to record the live view from a camera while simultaneously playing back video on that camera display. You must have the access privilege to play back recordings (see "Customizing a user's access privileges" on page 140 for more information).

Cameras in multiview mode play back simultaneously. This means, for example, that it is easy to follow the path of an intruder who has passed in front of several cameras.

You must be in live view mode to play back video.

### Overview of the playback window

It is easy to manage playback from the playback window.

The playback video can be set up to display a time/date stamp for evidentiary purposes (see "Configuring the camera OSD settings" on page 129).

**Figure 23: Playback window**



- |   |   |
|---|---|
| <ol style="list-style-type: none"> <li>1. Playback viewer.</li> <li>2. Camera panel. Select the cameras for playback. Move the mouse over the area to display the list of cameras available.</li> </ol> | <ol style="list-style-type: none"> <li>3. Calendar panel.<br/>Blue: Current date<br/>Yellow: Recordings available on the DVR.</li> <li>4. Playback control toolbar. See Figure 24.</li> </ol> |
|---|---|







## The playback control toolbar

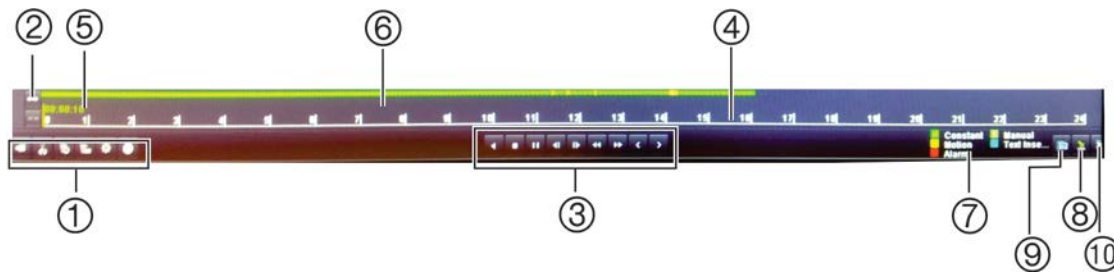









It is easy to manually control playback using the playback control toolbar. See Figure 24 below.

**Note:** The control toolbar does not appear for instant playback.

**Figure 24: Playback control toolbar (all-day playback example shown)**



Item	Description
1.	<b>Audio and video control toolbar:</b>
	 /  Audio on/off.
	 /  Start/stop a video clip during playback. Sections of a recording can be saved to an external storage device.
	 Add default bookmark
	 Add customized bookmark
	 Bookmark management. Click to see the list of bookmarks and their times.

Item	Description
	 Archive files
2.	<b>Zoom control:</b> Zoom in and out of the timeline to show the progress bar in greater or lesser detail.
3.	<b>Playback control toolbar:</b>
	 Reverse play the recording. Click again to pause.
	 Stop playback. Timeline jumps back to 00:00 time (midnight).
	 Play recording.
	 Forward skip playback. Default skip time is 30 seconds.
	 Reverse skip playback. Default skip time is 30 seconds.
	 Decrease playback speed: Options available are: single frame, 1/8 speed, 1/4 speed, 1/2 speed, normal, X2 speed, X4 speed, X8 speed, maximum speed.
	 Increase playback speed. Options available are: single frame, 1/8 speed, 1/4 speed, 1/2 speed, normal, X2 speed, X4 speed, X8 speed, maximum speed.
	 Previous file/day/event recording.
	 Play next file/day recording in the search result.
4.	<b>Timeline:</b> Allows you to jump forwards or backwards in time. The timeline moves left (oldest video) to right (newest video). Click a location on it for where you want playback to start. In all-day playback the cursor shows the actual time. In search playback, the cursor is a ball.
5.	<b>Time bar:</b> Time of actual playback. This is only displayed in all-day playback.
6.	<b>Playback progress bar:</b> This bar displays how far playback of the recording has progressed. It also indicates the type of recording.
7.	<b>Recording type:</b> Description of the color coding of recording types that appear in the playback progress bar. Dark green indicates continuous recording Red indicates alarm/event recording Yellow indicates motion recording Light green indicates manual recording Pale blue indicates text insertion recording
8.	Hide the playback control toolbar.
9.	<b>Video search:</b> Search for recordings. See “Searching recorded video” on page 56 for more information.
10.	For all-day playback mode, quit playback and return to live view. For playback from search mode, quit playback and return to the search screen.

## Playback pop-up menu

You can quickly access many playback functions by placing the cursor on a playback image on screen and clicking the right-button of the mouse. The playback pop-up menu appears (see Figure 12 below).

Figure 25: The playback pop-up menu

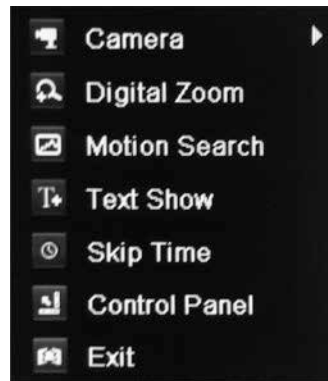

Item	Name	Description
1.	Camera	Select a camera for playback.
2.	Digital zoom	Enter the digital zoom function for the selected camera.
3.	Motion search	Call up the motion search toolbar to search playback recording for incidents of motion detection. See "Motion search" on page 62 for more information.
4.	Text show	Display inserted text on screen.
5.	Skip time	Modify the playback skip time. See "Playback skip time" on page 61 for more information.
6.	Control panel	Hide the playback control toolbar.
7.	Exit	Return to live view.

## Instant playback



Use the quick access toolbar to quickly replay recorded video for a preprogrammed time period. This can be useful to review an event that has just happened. Only one camera at a time can be selected. The default playback period is 5 minutes.

### To instantly replay recorded video:

1. In live view mode left-click the mouse on the desired camera image. The quick access toolbar appears. Click **Instant Playback** .
2. Select the desired camera from the drop-down list and click **OK**.

Playback starts immediately. The Instant Playback scroll bar appears under the selected camera.



3. Click **Pause**  on the toolbar to pause playback.  
Click **Play**  to restart playback.  
Click **Stop**  to stop playback and return to live view.

#### To change the instant playback time period:

1. Click **Display > Monitor > More Settings** in the menu toolbar.
2. Select the desired instant playback time: 5, 10, 20, or 30 minutes. The default time is 5 minutes.
3. Click **Apply**.

## All-day playback

Use this option to play back recorded video from the last day. Playback starts at midnight and runs for the 24-hour period. All-day playback is shown in full screen view. See Figure 24 on page 52 for a description of the playback control toolbar.

#### • Using the mouse:

1. In live view mode right-click the mouse on the desired camera image. In the mouse toolbar click **All-day Playback**.  
The playback screen appears. By default, the camera is in full-screen mode.
2. To select more than one camera for multiview playback or to select playback from a different day, move the mouse to the right edge of the screen. The camera list and calendar appear. Check the desired cameras and/or another day. Up to 16 cameras can be selected.

Playback starts immediately.

**Note:** A message appears if there are no recordings found during this period.

3. Use the playback control toolbar to manually control playback.
4. Click **Exit**  to return to live view.

– Or –

Right-click the mouse and click **Exit** from the mouse menu to return to the previous screen.

• **Using the front panel:**

1. Select the camera for play back and press the **Replay** button. Playback from the selected camera starts immediately.

**Note:** Multiview playback is only available using the mouse. If live view was showing multiview, only the camera in the top-left channel on screen will be played back.

2. To select a different camera for play back, press the numerical button of the desired camera.
3. Click **Live** to return to live view.

## Searching recorded video

You can easily search and play back recorded videos by time, events, bookmarks, and snapshots.

The Search screen has four submenus that allow you to carry out different searches by theme:

Search type	Description
Normal	Search all recorded video by cameras, recording type, type of file protection (locked or unlocked), and time period.
Event	Search only event recorded files. Files can be searched by alarm inputs, motion detection, or POS/ATM text insertion. <b>Note:</b> Only motion detection and POS/ATM text insertion that have been recorded as events will be listed in this search. Motion and text insertion that is recorded as a non-event can be searched under the Normal menu.
Bookmark	Search only recorded files with bookmarks.
Snapshot	Search only recorded files with snapshots.

## Search results

A search will usually produce a list of files, which may extend to several pages. The files are listed by camera, and then for each camera by date and time. The oldest file is listed first. See Figure 26 on page 57 for an example of a search.

Only one file can be played back at a time.

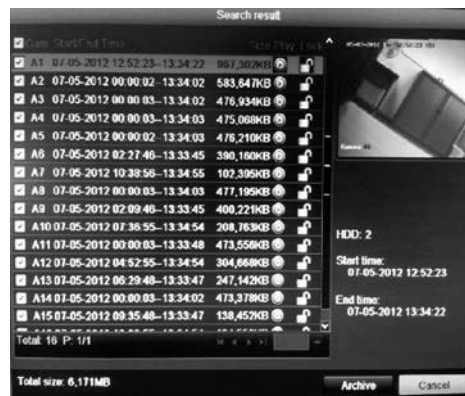

Figure 26: Example of a search result list



## Playing back recordings by time and video type

You can search recorded video by time and video type, such as continuous recordings, motion, text insertion, alarm and all recordings. Video can be played back simultaneously across several cameras.

### To play back search results:

1. In live view mode right-click the mouse and in the mouse menu select **Advanced Search > Normal**.
2. Select the desired cameras, record type, file type as well as start and end time of the recording.
3. Click **Search**. The list of search results appears.
4. Play back the search results:
  - If there is only one camera in the search result, click its playback  button. Playback starts.
  - If there is more than one camera listed, click the playback  button of one of the cameras. In the window that appears, select the cameras you want to play back simultaneously and click **OK**. Playback starts.
5. To hide the playback control toolbar during play back, right-click the mouse and select the **Control Panel** button in the playback control toolbar. Click again for the panel to reappear.
6. Use the playback control toolbar to manually control playback.
7. To play back another camera, move the cursor to the right edge of the screen to display the list of cameras and select the desired camera.
8. To do another search:
  - Click **Exit**  in the playback control toolbar to return to the search results screen.

- Or -

Right-click the mouse and select **Exit** from the list to return to the search results screen.

- Or -

Right-click the mouse and select **Video Search** from the list to return to the search screen.

## Playing back recordings by event

You can search recorded video by event type: motion, alarm input, and POS/ATM text insertion. Video can be played back simultaneously across several cameras.

### To play back search results:

1. In live view mode, right-click the mouse and select **Advanced Search > Event**.
2. Select the desired event type as well as start and end time of the recording.
3. Select the desired alarm inputs.

If you selected "Motion" as the event type, select the required alarm inputs. If you selected "Text insertion", select the required alarm inputs and enter the desired keywords.

4. Click **Search**. The list of search results appears.
5. Play back the search results:

If there is only one camera in the search result, click its playback  button. Playback starts.

If there is more than one camera listed, click the playback  button of one of the cameras. In the window that appears, select the cameras you want to play back simultaneously and click **OK**. Playback starts.

6. To hide the playback control toolbar during play back, right-click the mouse and select the **Control Panel** button in the playback control toolbar. Click again for the panel to reappear.
7. Use the playback control toolbar to manually control playback.
8. To play back another camera, move the cursor to the right edge of the screen to display the list of cameras and select the desired camera.
9. To do another search:

Click **Exit**  in the playback control toolbar to return to the search results screen.

- Or -



Right-click the mouse and select **Exit** from the list to return to the search results screen.



- Or -

Right-click the mouse and select **Video Search** from the list to return to the search screen.

## Creating and playing back bookmarked recordings

You can bookmark the important scenes in a recorded file for later reference.

Bookmarks flag the start of a scene. Up to 64 bookmarks can be saved in a video file. There are two types of bookmarks:

- **Default bookmark** : All default bookmarks have the same generic name, "Bookmark".
- **Customized bookmark** : The bookmark is given a name for easy identification. The same name can be used for several bookmarks.

Both types can be searched.

### To create a bookmark:

1. Open an all-day playback screen or the playback screen from a search result.
2. In the all-day playback recording, click the timeline bar where you want the bookmark to be. The green time line jumps to this position. Click the button for the type of bookmark you want, and enter the bookmark name if required.

In the playback recording from a search, click the scroll bar where you want the bookmark to be. The scroll bar ball jumps to this position. Click the button for the type of bookmark you want, and enter the bookmark name if required. The bookmark is saved.

3. Click the bookmark management  button to see the list of bookmarks saved. The name of a bookmark can be edited. The bookmark can also be deleted.

### To play back a bookmark:

1. In live view mode right-click the mouse and select **Advanced Search > Bookmark** in the mouse menu.
2. Select the desired cameras as well as start and end time of the recording to be searched. Also select the type of bookmark to be searched.

If searching for customized bookmarks, enter a keyword from the bookmark name.

Click **Search**. The list of bookmarks appears.

3. Select a bookmark and do one of the following:

Click the **Edit** button to edit a bookmark's name.

Click the **Delete** button to delete a bookmark.

- Or -



Click the **Play** button to play back a bookmark.

4. When finished, click **Exit**.

## Slideshow of snapshots

You can search recorded for video snapshots. See “Accessing frequently used commands” on page 34 on how to create snapshots.

### To play back search results:

1. In live view mode right-click the mouse and in the pop-up menu select **Advanced Search > Snapshot**.
2. Select the desired cameras as well as start and end time of the recording to be searched.
3. Click **Search**. The list of snapshots appears.
4. Select a snapshot to see it in the thumbnail window. Click its **Play**  button to see it in full-screen mode.
5. When in full-screen mode, move the cursor to the right edge of the screen to see the complete list of snapshot s found in the search. Click their Play buttons to see them in full-screen mode.
6. To see a slideshow of all the snapshots found, click the ► or ◀ buttons on the snapshot toolbar to sequence forwards or backwards through the shots.
7. To do another search:  
Click **Exit**  in the snapshot toolbar to return to the search results screen.  
- Or -  
Right-click the mouse and select **Exit** from the list to return to the search results screen.  
- Or -  
Right-click the mouse and select **Snapshot Search** from the list to return to the search screen.

## Playing back recordings from the system log

You can also playback recordings from the system log. The system log provides a much wider range of options for playback than Advanced Search, which deals with video detection and alarms only.

Figure 27: View log screen

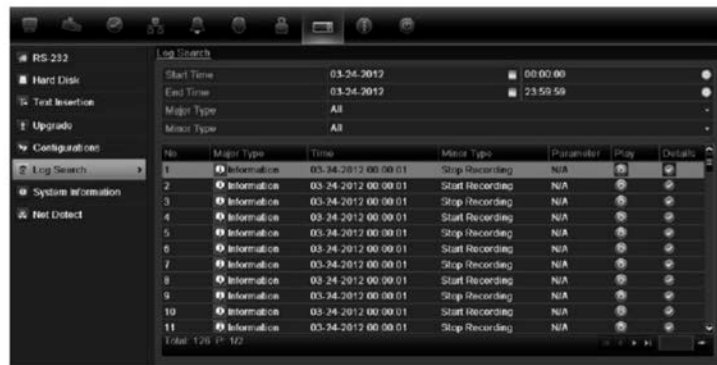

### To play back video from the system log:

1. Click **System Settings > Log Search** in the menu toolbar.
2. Select the search start and end times.
3. Under **Major Type** and **Minor Type**, select an option from the drop-down list. The minor type list of options available depends on the option selected under major type.
4. Click the **Search** button. A list of results appears.
5. Select a file and click:
  - **Details:** Displays information on the log or recording. For a recording, it lists such information as start time, type of information, camera number, and gives a description on the types of events recorded and when record time was stopped.
  - **Play:** Click to start playback of the selected recording.
  - **Export:** Click to archive the selected file to a USB device. The export screen appears.
  - **Back:** Click to return to the previous screen.

## Playback skip time

By moving the joystick up and down during playback, you can jump forwards or backwards by a defined skip time period.

### To change the playback skip time:

1. In playback mode, right-click the mouse and click **Skip Time** on the pop-up menu. The Skip Time menu appears.
2. Select a skip time between 10 and 300 seconds. The default skip time is 30 seconds.

## Motion search

You can quickly and easily search playback recording for incidents of motion detection. Motion can be searched over the whole playback screen or just for specific areas on it. This allows you to search, for example, whether any motion was detected a few days ago near a particular door.

The option is not available in instant playback.

Figure 28: Motion search toolbar

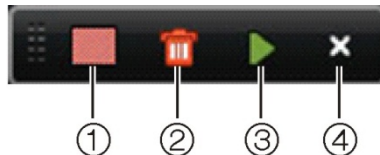

1. **Full screen detection:** The motion-sensitive red grid automatically appears over the whole screen.
2. **Delete all:** Delete the motion grid.
3. **Search:** Search the playback recording for motion detection.
4. **Exit:** Quit motion search mode and return to play back.

### To search for motion in playback:

1. In playback mode, right-click the mouse and click **Motion Search** on the mouse menu. The motion search toolbar appears and the playback control toolbar disappears.
2. Select an area of the screen to be searched:
 

Drag the mouse over the desired area. A red grid appears. More than one area can be selected.

- Or -

Click the full-screen detection icon in the toolbar. The whole screen is covered in the red grid.
3. Click the **Search** icon to see the results.
 

Motion appears as blue lines below the green playback progress bar. If motion had been recorded as an event, it appears as yellow on the progress bar.

Click the **zoom-in** button to see the progress bar in closer detail.

## Playing back frame-by-frame

You can easily play back a selected video at different speeds. This allows you to carefully examine an event frame-by-frame as it happens.

The current frame rate is shown on the right of the playback control toolbar.

#### To play back frame-by-frame:

- **Using a mouse:**

1. In playback mode click the **Speed Down** ⏪ and **Speed up** ⏩ buttons in the playback control toolbar until the speed changes to single frame.
2. Click the **Pause** button to advance the video frame by frame.

- **Using the front panel:**

1. In playback mode move the joystick to left and right to scroll down and up through the speed changes until single frame.
2. Press **Enter** with the joystick to advance the video frame by frame.
3. Press the **Playback** button to continue playback at normal speed.

## Digital zoom in playback

You can easily zoom in on an image during playback to see it in greater detail.

#### To digitally zoom-in during playback:

1. In playback mode right-click the mouse and click **Digital Zoom** in the pop-up menu. The playback control toolbar disappears.
2. Click the screen with the cursor.  
The image zooms in and the digital view screen appears.
3. Left-click the mouse and drag the red square to the area of interest, or move the joystick on the front panel to position the red square. The selected area is magnified.
4. Right-click the mouse to quit the digital zoom mode and to return to full-screen playback mode. The playback control toolbar reappears.



# Chapter 8

## Archiving recorded files

Archive recorded files on an external device such as a USB flash drives, USB HDDs, eSATA HDD or a DVD writer. You must be in live view mode to archive video. Access to archive commands may require a password.

Before starting to archive files, ensure that you have the backup device connected to the DVR. It can be detected automatically by the DVR.

**Note:** The USB port on the back panel does not support USB CD/DVD burners or USB HDDs.

### Archiving files

There are three ways to archive files from live view:

**Quick Archive:** Quick archive lets you archive recorded files quickly by using the Archive button on the front panel. The TVR 41 then downloads all the recorded files on the unit to fill the available memory space on the storage media. This option is not available via the mouse.

**Advanced Search screen:** Use this screen to specify archiving settings such as a specific time and date period, recording type, start and end times, as well as cameras.

**Auto archive:** You can schedule when to automatically archive recorded files.

### Using Quick Archive

**To archive recorded video using Quick Archive:**

1. Insert the backup device into the TVR 41.

If using a USB memory drive, insert the device into the USB port on the front panel. If using a digital video disk (DVD) or eSATA drive, insert the disc into the DVD drive. If more than one media type is found in the TVR 41, the USB device takes precedence over the others.

2. Press **Archive** on the front panel or remote control to open the quick archive screen.

3. From the list of files displayed, select the files you want to archive.
4. Click **Start**. The unit starts to download all the files listed.

**Note:** If there is a capacity limitation on the backup device, only the most recent files will be backed up.

A message will appear to confirm when the download is complete.

## Exporting recorded files to a backup device

There are two ways to archive files to a backup device. You can manually select the files to back up or you can schedule when the DVR will automatically archive.

You can insert a mini-USB hub to the USB port to attach a mouse for navigation or a USB drive for archiving. However, the unit may not support all types of USB hubs.

The Archive options available may depend on the type of backup device selected.

Figure 29: Example of an archive



Item	Function	Description
1.	Device name	Select one of the storage media for archiving. If the backup device is not recognized: <ul style="list-style-type: none"> <li>• Click the Refresh button</li> <li>• Reconnect device</li> <li>• Check for compatibility from vendor</li> </ul>
2.	Refresh	Refresh the search results if any parameters have been modified.
3.	Name	Files found on the backup device are listed.
4.	Delete	Click to delete a selected file from the backup device.
5.	Play	Click to play selected file.
6.	Free space	Free space available on the backup device is displayed.



Item	Function	Description
7.	Seal disc	Select to prevent other files being recorded onto the disc.
8.	Include Player	Select to automatically include the Player tool when archiving files.
9.	New folder	Create a new folder on the backup device. Files from the DVR can be archived to a specific folder.
10.	Format	Format the USB/eSATA drive.
11.	Archive	Start downloading selected files onto the backup device.
12.	Cancel	Cancel search and return to previous menu.

### To manually export recorded files to a backup device:

1. Connect the backup device to the DVR.

If using a USB memory drive, insert the device into the USB port on the front panel. If using a digital video disk (DVD) or eSATA drive, insert the disc into the DVD drive. If both media are found in the TVR 41, the USB device takes precedence over the DVD.

2. In live view mode press the **Search** button on the front panel or remote control.

- Or -

Right-click the mouse and select **Advanced Search**.

The Advanced Search screen appears.

3. Select the cameras and search parameters required:

**Record type:** All, constant, motion, text insertion, alarm, or manual.

**File type:** All, locked, or unlocked.

4. Select the start and end dates and times to archive recordings.

**Note:** You can click the **Quick Playback** button to verify that the selected files are the files to export. Right-click the mouse and click **Exit** to return to the Advanced Search screen.

5. Click **Search**. The list of results appears.

6. Select the files to export.

7. Click **Archive**. The Archive screen appears.

8. Select the storage medium to export to from the drop-down list.

9. Click **Archive** to begin the backup process.

10. Click **OK** when archiving is completed. Click **Cancel** until you return to live view.

## Auto archiving

You can schedule the DVR to automatically archive recordings at set interval times to an external storage device. You can also select the cameras and recording types to auto archive as well as define how the system responds when the HDD becomes full.

It is easy to see the time of the most recent and next archive recording. Simply select the Archive Status tab and the information is displayed.

### To schedule automatic archiving:

1. Connect the backup device to the DVR.
2. In the configuration menu, click **Video Schedule > Auto Archive > Archive Settings**.

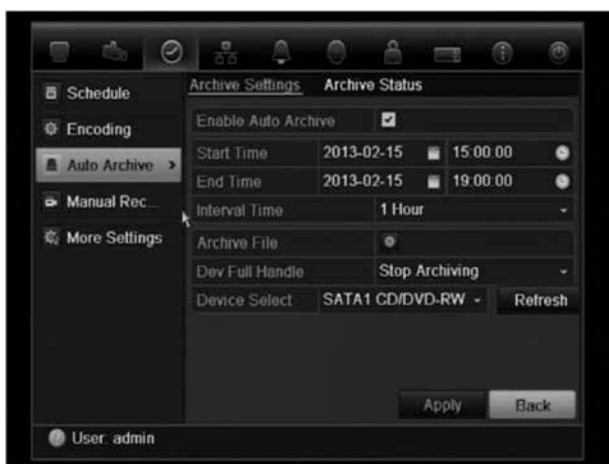

3. Check **Enable Auto Archive**.
4. Select the start and end date and time periods during which archiving can occur automatically.
5. Under **Interval Time**, select the desired interval time for archiving.  
The interval time options available are: 1 hour, 2 hours, 4 hours, 8 hours, 24 hours, or once only. Default is 1 hour.
6. Click **Archive file**. In the screen that appears, select the cameras and search parameters required:

**Record Type:** All, constant, motion, text insertion, alarm, or manual.

**File Type:** All, locked, or unlocked.

**Note:** You can copy these selected parameters to other cameras. Click **Copy** and select the desired cameras.

Click **OK** and **Apply** to save, and return to the Archive Settings screen.

7. Select how the DVR responds if the backup device becomes full. There are two options: Stop Recording or Overwrite.

If overwrite is selected, the oldest files are overwritten.

8. Under **Device Select**, select the backup device used.
9. If you change any options, click **Refresh**.
10. Click **Apply**.



## Creating and archiving video clips

You can save important scenes in a recorded file for later reference by creating video clips of selected portions of the file during playback. When an intruder, for example, crosses in front of several cameras you can save the video clip of the intruder's path across these cameras in a single file.

Up to 30 video clips can be made from a recording.

**Note:** This feature is only available using the mouse.

### To manually export video clips during playback:

1. Connect the backup device to the DVR.
2. Search for the required files to play back. See "Searching recorded video" on page 56.
3. Select the file or files to play back and click **Play**. Playback starts immediately.
4. Click the playback timeline where you want the video clip to start and click the **Start Clip**  button.
5. Click the playback timeline where you want the video clip to stop and click the **End Clip**  button.
6. Repeat for additional clips.
7. Exit playback mode. A message appears asking if you want to save the video clips.
8. Click **Yes** to archive the clips. The Export screen appears.  
Click **No** to exit and return to the search results screen. The clips are not saved.
9. In the Export screen select from the drop-down list the backup device to be used.
10. Click **Start**. File downloading starts.

**Note:** You can create a new folder for the video clips. Press the **New Folder** button and enter the folder name.

## Archiving snapshots

You can save all the video snapshots recorded to a backup device.

### To manually archive snapshots:

1. Connect the backup device to the DVR.
2. Search for the required snapshot files to play back. See “Slideshow of snapshots” on page 60. The list of snapshots appears.
3. Select the snapshots to backup.
4. Click **Archive**. Select the archiving device, if different from that listed.
5. Click **Archive**. Export starts immediately.
6. When completed, click **OK**. Click **Cancel** to return to the previous screen.

## Managing backup devices

You can manage backup devices from the Export screen (see Figure 29 on page 66.)

The Export screen allows you to:

- **Create New Folder:** Create a new folder on the backup device.
- **Delete:** Delete a file or folder from the backup device.
- **Play:** Play the selected video file from the backup device.
- **Format:** Format the backup device.
- **Erase:** Erase files from a re-writable CD/DVD.

## Playing back archived files on a PC

Use the standard file player software to play back the archived video on your PC. It is downloaded automatically from the TVR 41 when archiving files onto a backup device.

# Chapter 9

## Using the web browser

This chapter describes how you can use the web browser interface to configure the device, play back recorded video, search through event logs, and control a PTZ dome camera. You can also specify settings on the web browser interface to optimize video playback and recording performance when operating in a low or limited bandwidth environment.

### Windows Vista and 7 users

Internet Explorer for Windows Vista and Windows 7 operating systems have increased security measures to protect your PC from any malicious software being installed. When using the TVR 41 web browser interface, you can install ActiveX controls to connect and view video using Internet Explorer.

To have complete functionality of the web browser interface and the DVR player with Windows Vista and Windows 7, do the following:

- Run the browser interface and the DVR player application as an administrator in your workstation
- Add the DVR's IP address to your browser's list of trusted sites

#### **To add the DVR's IP address to Internet Explorer's list of trusted sites:**

1. Open Internet Explorer.
2. Click **Tools**, and then **Internet Options**.
3. Click the Security tab, and then select the Trusted Sites icon.
4. Click **Sites**.
5. Clear the "Require server verification (https:) for all sites in this zone" box.
6. Enter the IP address or DDNS name in the "Add this website to the zone" field.
7. Click **Add**, and then click **Close**.
8. Click **OK** in the Internet Options dialog screen.
9. Connect to the TVR 41 for full browser functionality.

## Accessing the web browser

To access the TVR 41, open a web browser and enter the IP address assigned to the DVR as a web address. On the logon screen, enter the default user ID and password.

**Note:** Only one DVR can be viewed per browser.

User ID: admin

Password: 1234

The default values for TVR 41 network settings are:

- IP address - 192.168.1.82
- Subnet mask - 255.255.255.0
- Gateway address - 192.168.1.1
- Ports:

When using the browser:

RTSP port: 554

HTTP port: 80

When using TruNav:

RTSP port: 554

Server/Client software port: 8000

For more information on port forwarding, see Appendix C “Port forwarding information” on page 153.

## Web browser overview

The TVR 41 web browser lets you view, record, and play back videos as well as manage all aspects of the DVR from any PC with Internet access. The browser’s easy-to-use controls give you quick access to all TVR 41 functions. See Figure 30 below.

Figure 30: Live view in the web browser interface

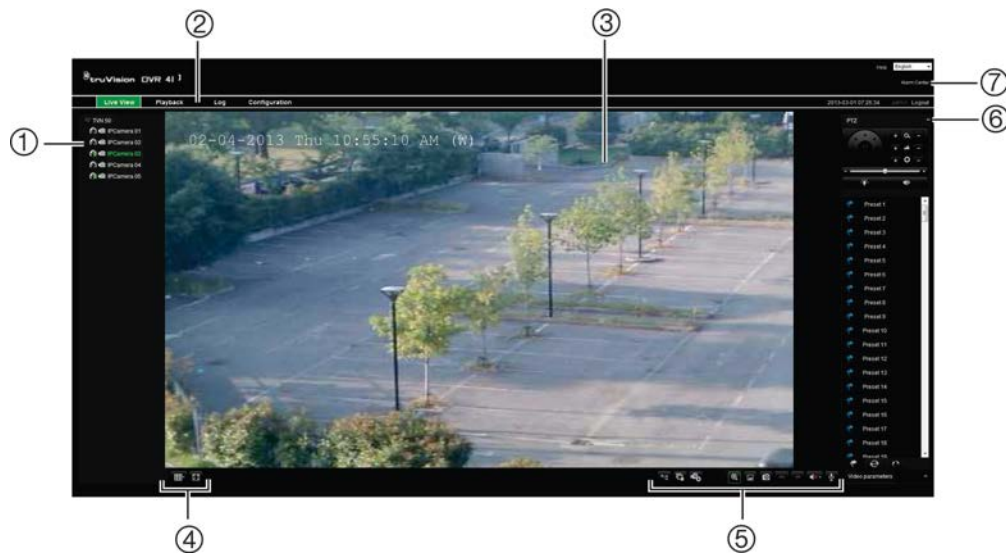











Table 16: Description of live view in the web browser

Item	Name	Description
1.	Camera	View video and record video from the selected camera.
2.	Menu toolbar	Lets you do the following: <ul style="list-style-type: none"> <li>• View live video</li> <li>• Play back video</li> <li>• Search for event logs</li> <li>• Configure settings</li> <li>• Log out of the interface</li> </ul>
3.	Viewer	View live or playback video.
4.	Display format	Define how you want video to be displayed in the viewer: Multiview or full screen.
5.	Video function toolbar	Lets you do the following in live view: <ul style="list-style-type: none"> <li> Switch between main stream and substream.</li> <li> Start/stop all streaming from selected cameras.</li> <li> Start recording from selected cameras.</li> <li> Access digital zoom.</li> <li> Turn POS/ATM text insertion on/off.</li> <li> Take a video snapshot.</li> <li> View previous and next camera respectively.</li> <li> If viewing in multiview format, live view moves to the next group of cameras for the selected number of video tiles.</li> <li> Turn audio on/off</li> </ul>

Item	Name	Description
		 Turn microphone on/off
6.	PTZ panel	Hide/display the PTZ panel.
7.	Alarm center	Display a log of unacknowledged alarms.

## Using the web browser to configure the device

Click **Configuration** on the browser menu bar to display the configuration screen. There are two ways to configure the DVR: Local and Remote.

### Local configuration

Local configuration lets you define communication and network parameters such as protocol type, maximum file size, stream type and network transmission settings. You can also specify the directory locations for saving recorded and playback video, captured images, and downloaded files.

### Remote configuration

See Figure 31 below for an example of the Configuration screen. See Table 16 on page 73 for an overview of the different browser menu functions. Please refer to the specific sections on the OSD menu functions for more information on configuring these functions.

**Note:** The configuration settings defined remotely are different from those that can be defined locally.

Figure 31: Remote browser configuration (System information - HDD screen shown)

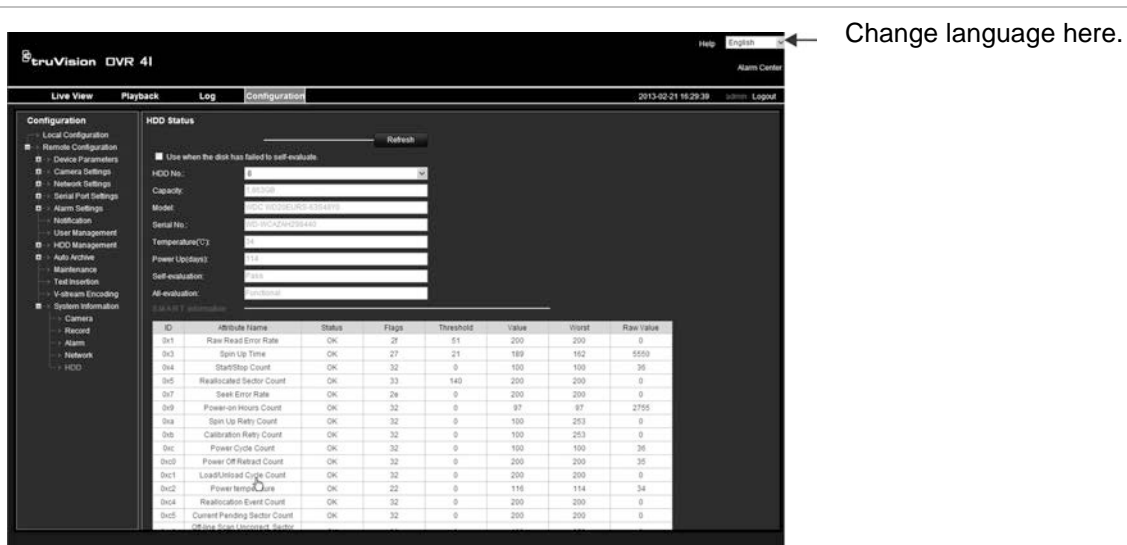

Change language here.

ID	Attribute Name	Status	Flags	Threshold	Value	Worst	Raw Value
0d1	Raw Read Error Rate	OK	29	51	200	200	0
0d3	Spin Up Time	OK	27	21	189	162	8508
0d4	Start/Stop Count	OK	32	0	100	100	35
0d5	Reallocated Sector Count	OK	33	140	200	200	0
0d7	Seek Error Rate	OK	26	0	200	200	0
0d9	Power-on Hours Count	OK	32	0	97	97	2755
0da	Spin Up Retry Count	OK	32	0	100	253	0
0db	Calculation Retry Count	OK	32	0	100	253	0
0dc	Power Cycle Count	OK	32	0	100	100	35
0dd0	Power Off Retract Count	OK	32	0	200	200	35
0dc1	Load/Unload Cycle Count	OK	32	0	200	200	0
0dc2	Power Temp. Curs	OK	22	0	116	114	34
0dc4	Reallocation Event Count	OK	32	0	200	200	0
0dc5	Current Pending Sector Count	OK	32	0	200	200	0



**Table 17: Description of remote configuration menus**

Menu	Function	Description
Device parameters	Device information	<p><b>Device name:</b> Define the DVR name. The default name is TVR 41.</p> <p><b>Device number:</b> The device number to use for the DVR when programming the remote control. The default value is 255.</p> <p><b>Zone ID:</b> Each DVR in a daisy chain must have a unique zone ID so that it can be controlled by a KTD-405. The default value is 1.</p> <p><b>Overwrite:</b> Enable or disable. Enabling this setting causes recorded files to be overwritten once the HDD is full.</p> <p><b>eSATA:</b> Define how an external recording device saves records. See “Using an external recording device” on page 89 for more information.</p> <p><b>Event priority:</b> Define the priority between text insertion event and motion alarm if both are triggered at the same time. Default is Motion alarm (Text In &lt; Motion).</p>
	Time settings	Define time and date. See “Configuring time and date” on page 38 for more information. See “Configuring an NTP server” on page 112 for information on setting up NTP time settings.
	Holiday settings	Define when recordings occur during holiday periods. See “Holiday schedules” on page 92 for more information.
Camera settings	Display settings	Define which information is displayed on-screen. See “Configuring the camera OSD settings” on page 129 for more information.
	Video settings	Define general recording settings. See “Defining a recording schedule” on page 90 for more information.
	Recording schedule	Define the recording schedules. See “Defining a recording schedule” on page 90 for more information.
	Motion detection	Define motion detection parameters. See “Setting up motion detection” on page 100 for more information.
	Privacy mask	Define the on-screen privacy mask areas. See “Setting up privacy masking” on page 130 for more information.
	Tamper-proof	Define the video tampering detection settings. See “Detecting video tampering” on page 106 for more information.
	Video loss	Define the video loss detection settings. See “Detecting video loss” on page 105 for more information.
	Text overlay	Add extra lines of text on screen. See “Text overlay” on page 83.

Menu	Function	Description
	Image	Adjust image quality on screen. See “Adjusting camera image settings” on page 131 for more information.
	Covert camera	Define the cameras whose images cannot be displayed by those not logged in. See “Hiding a camera image from view” on page 131 for more information.
	Capture settings	Define the image quality of snapshots.
	Manual record	Define which cameras can manually record. See “Manual recording” on page 93 for more information.
Network settings	General	Define the general network settings. See “Configuring general network settings” on page 109 for more information.
	PPPoE	Define the PPPoE settings. See “Configuring PPPoE” on page 110 for more information.
	DDNS	Define the DDNS settings. See “Configuring DDNS” on page 111 for more information.
	Email	Define the settings to send an e-mail. See “Configuring e-mail” on page 112 for more information.
	NetHDD	Define the remote storage system for DVR recordings. See “Using a network storage system” on page 84 for more information.
	UPnP™	Enable this function so that the DVR can automatically configure its own port forwarding. See “Configuring UPnP™” on page 113 for more information.
	SNMP	Define the SNMP settings. See “Configuring SNMP” on page 115 for more information.
	FTP	Define the FTP settings. See “Configuring PPPoE” on page 110 for more information.
	More settings	Define a remote alarm host, multicast IP as well as the server, HTTP and RTSP ports. See page 115 for more information.
Serial port settings	232 serial port	Define the RS-232 parameters. See “Configuring the RS-232 port” on page 133 for more information.
	485 serial port	Define the RS-485 parameters.
Alarm settings	Alarm input	Define the alarm input parameters for when an external alarm is triggered. See “Setting up external alarms” on page 102 for more information.
	Alarm output	Define the response when an external alarm is triggered. See “Setting up external alarms” on page 102 for more information.
	Alarm audio	Define the parameters to import an alarm audio file. See “Alarm audio messages” on page 98.







Menu	Function	Description
	Audio output	Define the parameters to import an alarm audio file. See “Alarm audio messages” on page 98.
	Advanced settings	Define the warning buzzer time. See “Modifying the warning buzzer” on page 100 for more information.
Notification		Define the notification parameters when irregular events occur such as HDD full. See “Description of alarm notification types” on page 97 and “Setting up system notifications” on page 105.
User management		Define, modify, and delete users. See Chapter 16 “User management” on page 139 for more information.
HDD management	Basic settings	Initialize the HDD. See “Initializing HDDs” on page 121 for more information.
	Storage settings	Define the storage capacity of the HDD. See “Controlling disk space on the HDD” on page 121 for more information.
Auto archive	Archive settings	Define archive scheduling as well as camera and recording type selection. See “Auto archiving” on page 68 for more information.
	Archive status	Review archive status. See “Auto archiving” on page 68 for more information.
Maintenance		Remotely update the DVR firmware, restore default factory settings, restart the DVR, and import parameters remotely. See Chapter 15 “DVR management” on page 133 for more information.
Text insertion		Define access device, access mode, and start string. See “Capturing text insertions” on page 81.
V-stream encoding		Define the maximum bit rate and frame rate. See “V-stream encoding” on page 42 for more information.
System information	Camera, Record, Alarm, Network, and HDD	Review the status of the cameras, recordings, alarms, network, and HDDs. See “Viewing system information” on page 136 for more information.







## Searching and playing back recorded video

To search and play back recorded video, click Playback on the menu bar to display the Playback page shown in Figure 32 on page 78.

Figure 32: Browser playback page



Item	Description
1.	Selected camera.
2.	<b>Calendar:</b> Selected day is highlighted.
3.	<b>Search:</b> Click to start searching recorded files for the selected camera.
4.	<b>Dual stream:</b> Select desired dual stream mode: Normal record, thin record, or picture. Default is Normal record.
5.	<b>Text search:</b> Check and then enter the text to search.
6.	<b>Display format:</b> Click to change the display format: full screen or multiview display.
7.	<b>Timeline:</b> The timeline moves left (oldest video) to right (newest video). Click a location on the timeline to move the cursor to where you want playback to start.
8.	<b>Playback control toolbar:</b>
	 <b>Reverse:</b> Click to reverse playback.
	 <b>Start/stop:</b> Start or stop playback.
	 <b>Stop playback.</b> Timeline jumps back to 00:00:00 time (midnight) of the previous day.
	 <b>Playback slow forward:</b> Click to scroll through the different speeds available: single frame, 1/8 speed, 1/4 speed, 1/2 speed, normal, X2 speed, X4 speed, X8 speed, maximum speed. Current speed is displayed under the camera name on top right of window.
	 <b>Playback fast forward:</b> Click to scroll through the different speeds available: single frame, 1/8 speed, 1/4 speed, 1/2 speed, normal, X2 speed, X4 speed, X8 speed, maximum speed. Current speed is displayed under the camera name on top right of window.
	 <b>Single frame:</b> Click to play back one frame at a time.
9.	 <b>Stop streaming:</b> Stop streaming from all cameras.
10.	<b>Audio and video control toolbar:</b>

Item	Description
	<b>Text insertion:</b> Click to enable/disable POS/ATM text display in playback.
	<b>Snapshot:</b> Capture a snapshot of the video.
	<b>Video clips:</b> Start/stop video clip during playback. Sections of a recording can be saved to an external storage device.
	<b>Download:</b> Download video clips.
	<b>Backup:</b> Click to make back up of recorded files to save locally on the DVR. A list of the recorded files appears
	<b>Audio:</b> Click to enable/disable audio.
11.	<p><b>Type of recording:</b></p> <p><b>Green:</b> Indicates video recorded based on the recording schedule defined.</p> <p><b>Red:</b> Indicates video recorded that was triggered by an alarm event.</p> <p><b>Yellow:</b> Indicates video recorded that was triggered by motion detection.</p> <p><b>Blue:</b> Indicates video recorded that was triggered by a POS/ATM text recording.</p> <p><b>Pale green:</b> Indicates manually recorded video.</p>
12.	<b>Jump start:</b> Enter a precise time in the box and click the Go To button to jump start the playback at this selected time.

Select a camera and a day to search from on the calendar displayed, and then click **Search**. The timeline below the page indicates video recorded for the specified day. The timeline also classifies by color the type of recording with each type.

Click and drag the marker across the timeline on where you want video playback to begin, and then click **Play** on the playback control toolbar. You can capture a snapshot of a video image, save the video playback, or download the recorded video.

## Searching for event logs

The DVR compiles a log of events, such as the start or end of video recording, DVR notifications, and alarms, through which you can easily search. Logs are categorized by the following types:

- **Alarm:** Includes motion detection, tamper detection, video tampering, and other alarm events
- **Notifications:** Includes system notifications such as video loss, HDD failures, and other system-related events
- **Operations:** Includes users access to the web interfaces and other operational events
- **Information:** Includes general information on the DVR actions, such as the start and end of video recording, etc.

To search for logs, click the **Log** tab in the browser toolbar, select a log type, specify a date and time range, and then click **Search**.

# Dual streaming

The DVR allows you to view from up to 16 cameras over a network. Dual streaming allows high quality video to be viewed in one stream (Normal stream) and lower quality video to be viewed in another stream (Stream B) that can be easily streamed through a narrow bandwidth.

The normal stream has the frame rate, quality, and resolution as configured in the encoding menu. However, in a thin stream data thinning has been carried out so that it has a lower frame rate, quality, and resolution. This allows more video to be recorded on the HDD.

Dual streaming is available in both live and recording modes.

## To play back dual streaming:

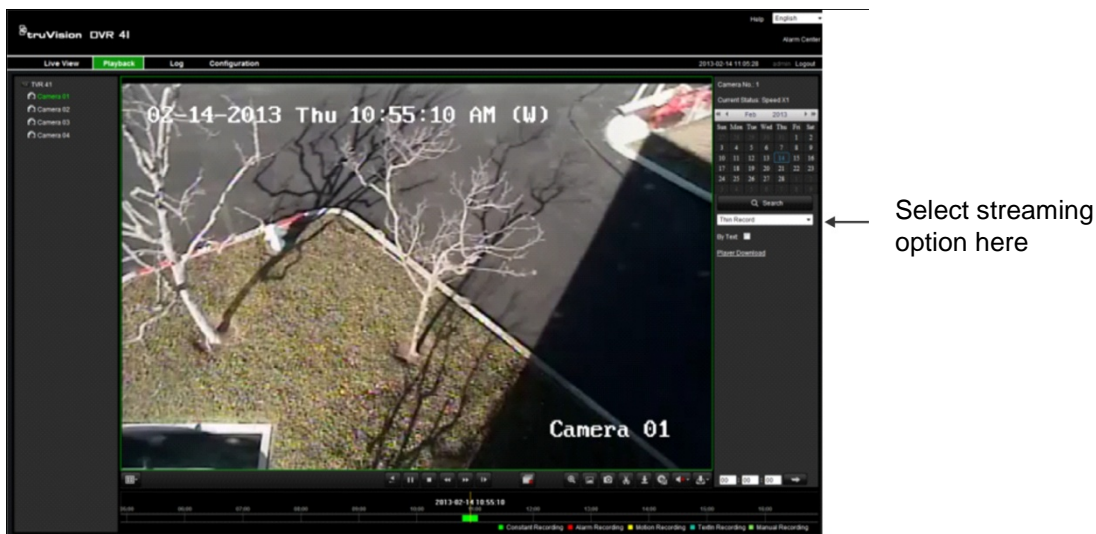

## To record dual streaming:

1. Click the Configuration tab in the browser toolbar and then select **HDD management > Storage Mode**.

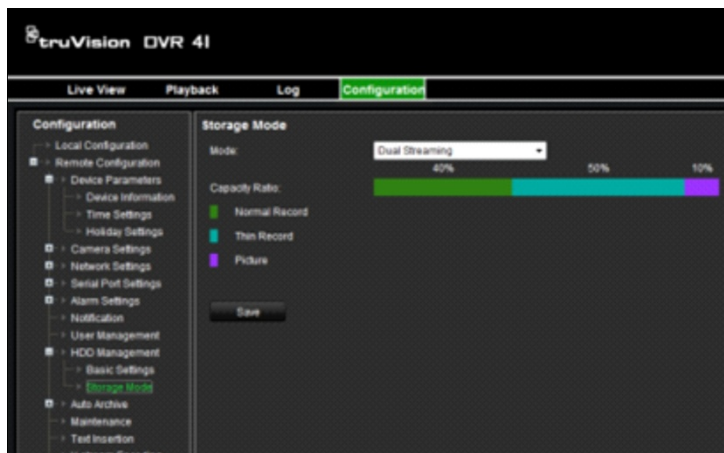

2. Specify which percentage of the HDD should be used to store normal streams (Normal Record), thin streams (Thin Record), and snapshots (Pictures).

Using the mouse, drag the markers between the colored sections to the desired values. The minimum and maximum values for each recording type are:

Normal record: 20 to 50%

Thin record: 0 to 80%

Picture: 0 to 20%

3. Click **Save** to save the settings.

## Controlling a PTZ dome camera in the web browser

The web browser interface lets you control the PTZ functions of a dome camera. Click a PTZ dome camera and use the PTZ controls on the interface to control the PTZ functions.

**Figure 33: PTZ controls**

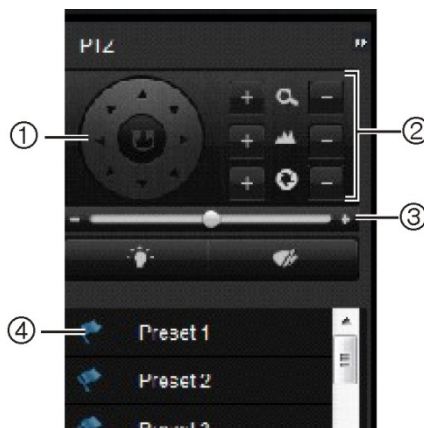

1. Directional pad/auto-scan buttons: Controls the movements and directions of the PTZ. Center button is used to start auto-pan by the PTZ dome camera.
2. Adjust zoom, focus, and iris.
3. Adjust speed of PTZ dome camera.
4. Start selected preset.

## Capturing text insertions

Text insertion lets you insert or display text from a point-of-sale (POS) system on the video display of the DVR. The text is saved and time-stamped together with the video. You can then search the text for specific video clips. The text is displayed during playback.

The DVR supports POS and ATM text insertion via the UTC ProBridge accessory connected to the RS-232 port on the DVR. This feature is currently only available using the browser.

In both live view and playback, a camera set up for text insertion will display the video with the POS text overlay.

See Figure 34 below for an example of a video image in live view with text insertion.

Figure 34: Example of a video image with text insertion



### To set up text insertion:

1. Click the **Configuration** tab in the browser toolbar and then select **232 Serial Port**.



2. Under **Usage**, select ProBridge.
3. In the submenu panel, select **Text Insertion**.



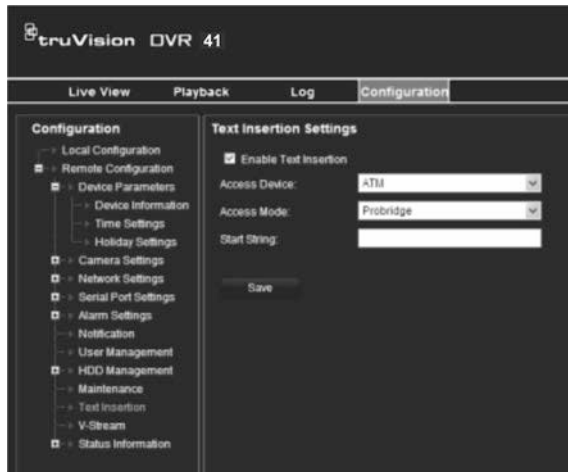

4. Check **Enable text insertion**.
5. Select the access device from the drop-down list.
6. Select the access mode. Only “ProBridge” is listed.
7. Under Start String, enter the desired transaction text, such as an ATM transaction number.
8. Click **Apply** to save the settings.

#### To search text insertion in recorded video:

1. In live view, check the **By text** check box.

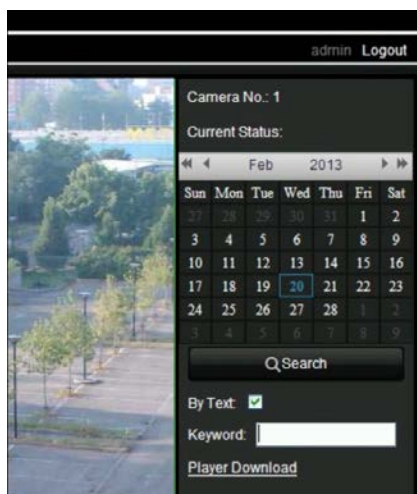

2. In the keyword text box that appears, enter the text for which you want to search.

## Text overlay

You can add up to eight lines of text on screen via the browser. This option can be used, for example, to display emergency contact details. By default these lines of text are positioned along the top of the screen. The strings follow each other consecutively.

**Note:** This option is not available via the DVR.

**To add on-screen overlay text:**

1. Click the **Configuration** tab in the browser toolbar and then select **Camera Settings > Text Overlay**.

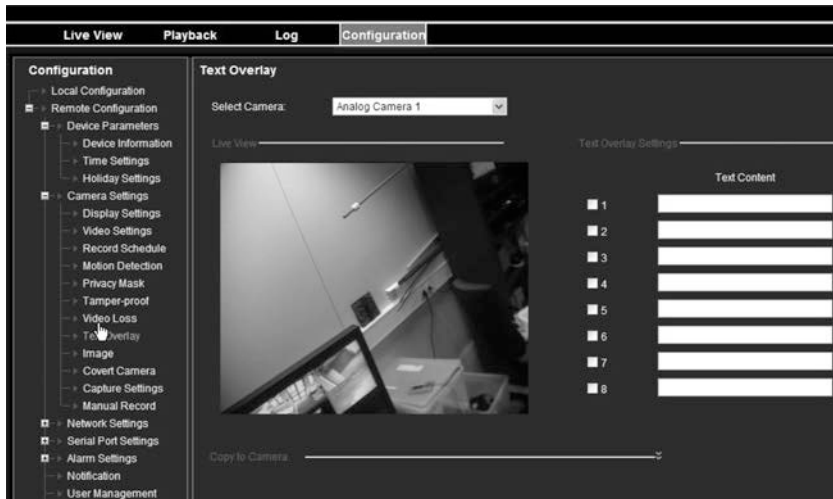

2. Select the desired camera.
3. Check the string box 1 for the first line of text.
4. Enter the text for string 1 in the column alongside. Up to 22 alphanumeric characters can be used.
5. Repeat steps 3 and 4 for each extra line of text, selecting the next string number.
6. Click **Save**.

## Using a network storage system

You can use a network storage system (NAS) or storage area network (SAN) to remotely store DVR recordings.

**To set up a network storage system:**

1. Click the **Configuration** tab in the browser toolbar and then select **Network Settings > NetHDD**.



2. On the first line of HDD No., enter the IP address of the desired remote storage system.
3. Enter the file path name to define where on the remote storage system you want to store the files.
4. Under Type, select type of storage system to be used: NAS or SAN. Default is NAS.
5. Up to eight remote storage systems can be set up.
6. Click **Save**.



# Chapter 10

## Recording

This chapter provides instructions on how to define the recording settings of your DVR. This chapter covers how you can configure your initial recording settings, schedule recordings, protect your recorded files, and set up your HDD for redundancy.

### Initializing recording settings

Before you can set up your DVR to begin recording, you must first configure general recording settings for the analog cameras.

Ensure that the HDD has been installed and initialized before configuring the recording settings. See Chapter 13 “HDD management” on page 121 for more information.

See “Calculating the maximum permitted frame rates and bit rates” on page 89 to calculate the maximum frame and bit rates.

#### To configure recording settings:

1. Click the **Video Schedule** icon in the menu toolbar.
2. Select **Encoding > Record**.



3. Select the camera you want to configure.

## 4. Configure the following recording settings:

- **Encoding parameters:** Select one of the stream types: Mainstream (TL-Hi, Mainstream (TL-Lo), Mainstream (Event), Mainstream (Alarm), or Substream.
- **Stream type:** Select the type of stream to record, either video or video and audio.
- **Resolution:** Select the resolution of the recording. Options include: 4CIF, 2CIF, CIF, and QCIF.
- **Bit rate type:** Select Constant or Variable.
- **Video quality:** Select the quality at which to record. If “Variable” was selected as the bit rate type, this option is unavailable.
- **Frame rate:** Select the recording frame rate. 25 PAL (30 NTSC), 20, 18, 16, 15, 12, 10, 8, 6 (default), 4, 2, 1, 1/2, 1/4, 1/8, 1/16. Default is 25 (30).
- **Max bit rate mode:** Select the general default or customized option.
- **Max bit rate (kbps):** If the customized maximum bit rate mode was selected, enter the value here. It must be between 32 and 4096 kbps. It is calculated from the frame rate and time required.
- **Pre-record:** This is the time the camera starts recording before the scheduled time or event. Select the time in seconds to start pre-recording before the scheduled time or event.

The maximum pre-recording times available depend on the constant bit rate. See “Maximum pre-recording times” on page 163 for more information.

- **Post-record:** This is the time the camera continues to record after the scheduled time or event. Select the time in seconds to stop post-recording after the scheduled time or event.
- **Auto-delete (day):** Select the number of days after which recorded video from the specified camera is permanently deleted from the HDD. A “day” is defined as the 24-hour period from when the auto delete mode (ADM) was set.

The maximum number of days that can be set is 60. However, the actual number of days permitted depends on the HDD capacity. If the value is set to ‘0’, the option is disabled.

- **Record audio:** Select **Yes** to record sound with the images.

5. Click **Apply** to save the settings.6. If you want to save these parameters to another camera, click **Copy** and select the camera in the pop-up screen that appears. Click **OK** and return to the main screen.7. Click the **Capture** tab and configure the settings for captured video, such as snapshots. Click **Apply** to save the settings.

8. Click **Back** to return to live view.

## Calculating the maximum permitted frame rates and bit rates

You can easily calculate the correct frame rates, bit rates, and HDD free space required for your system.

**Note:** If you should later change any recording parameters, the calculated values will no longer apply.

### To configure recording settings:

1. Click the **Video Schedule** icon in the menu toolbar.
2. Select **Encoding > Encode parameters suggestion**.

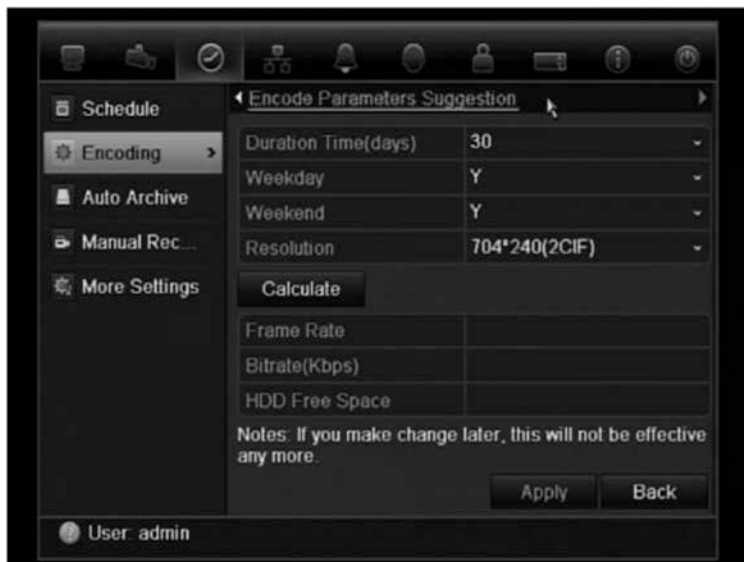

3. Enter the number of days to be recorded and the resolution. Also specify whether the recording period will include weekdays and weekends.
4. Click **Calculate**. The recommended maximum values for the frame rate, bit rate, and HDD free space are then displayed.

Use this information when setting the recording parameters.

**Note:** This option is not available via the browser.

## Using an external recording device

You can use an external storage device, such as an eSATA HDD, to backup video or to add its recording capacity to that of the DVR itself. If you change this option, you must reboot the DVR to implement the change.

### To configure for an external recording device:

1. Click the **Video Schedule** icon in the menu toolbar.
2. Select **More Settings**.

3. Select one of the two options:

**Record and Capture:** Extend the recording capacity of the DVR.

**Export:** Backup data onto an eSATA backup device.

**Note:** If the external storage device is part of the total internal capacity of the DVR, then it is no longer available for backing up video.

4. Click Apply.

## Configuring overwrite

You can select how the DVR responds when the HDDs become full and there is no longer sufficient space to save new data.

**To configure for overwrite when the HDDs are full:**

1. Click the **Video Schedule** icon in the menu toolbar.
2. Select **More Settings**.
3. Under **Overwrite**, select **Yes**.

## Defining a recording schedule

Defining a recording schedule lets you specify when the DVR records video and under what circumstances. Each camera can be configured to have its own recording schedule.

The schedules are visually presented on a map for easy reference. See Figure 35 below for an example.

**Figure 35: Description of the Schedule screen**

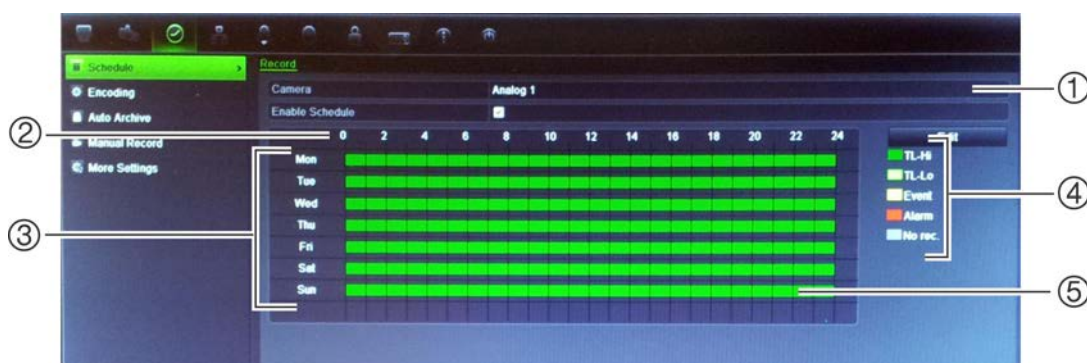

1. **Camera.** Select a camera.
2. **Schedule time.** Represents the 24-hour cycle during which a schedule is selected.
3. **Schedule day.** There are seven days to select: Sunday (Sun), Monday (Mon), Tuesday (Tue), Wednesday (Wed), Thursday (Thu), Friday (Fri), and Saturday (Sat).
4. **Recording type.** There are five recording types to select, which are color-coded:



- TL Time lapse (Green squares): Record of a specific day. Each green square in the timeline represents an hour in the 24-hour period.
  - TL-Hi (Dark green): High quality time lapse. Records high quality video.
  - TL-Lo (Bright green): Low quality time lapse. Records low quality video. This could be used, for example, for night recordings when few events or alarms are expected. Saving the video in low quality helps save resources on the HDD.
  - Event (Yellow): Records only events, such as motion detection and POS/ATM text insertion.
  - Alarm (Red): Records only alarms.
  - None (Grey): No recording during this period.
5. **Timeline.** There is a 24-hour time line for each day. Up to eight recording periods can be scheduled during the 24-hour period.

## Daily schedules

### To set up a daily recording schedule:

1. Click the **Video Schedule** icon in the menu toolbar and select **Schedule**.
2. Select a camera.
3. Check the **Enable Schedule** box.
4. Click **Edit**. The following screen is displayed:



5. Select the day of the week for which you want to set up the schedule. You can define a schedule for each day of the week.

Check **All Day** to select the whole week.

6. Set the start and end time for recording.

Define a time period by entering a start (left column) and end (right column) time. You can schedule up to eight time periods. Click All Day to record all day.

**Note:** The time periods defined cannot overlap.

7. Select a recording type.

This setting instructs the DVR to begin recording when an alarm is triggered. The recording type can be based on time and triggered by motion detection and/or an alarm. If set to TimeLapse (TL-Hi or TL-Lo), the DVR records continuously.

8. Click **Apply** to save settings.

- Repeat steps 3 to 8 for other days of the week or to copy the schedule settings to another day.

To copy the current schedule settings to another day of the week, click **Copy**. Select the number of the day of the week to which to copy the schedule and click **OK** to save changes and return to the Edit screen.

- Repeat steps 3 to 9 for other cameras.
- Click **Apply** to save the settings, and then **OK** to return to the schedule screen.

## Holiday schedules

As well as being able to schedule when recordings occur during the week, you can also schedule them for specific holidays in the year such as, for example, the first of January, or the second Wednesday of every month. You can schedule up to 32 holiday periods.

A holiday period can be scheduled for a particular day or as a block of days.

### To set up a holiday recording schedule:

- Click the **Display Mode Settings** icon in the menu toolbar, and select **Holidays**.
- Select a holiday period from the list, and click **Edit** to modify the settings. The Edit screen appears.

Holiday Name	Holiday1		
Enable	<input type="checkbox"/>		
Mode	By Month		
Start Date	Jan	1	
End Date	Jan	1	

Apply OK Cancel

- Enter the name of the holiday period, and click **Enable**.
- Select whether the holiday period will be categorized by date, week or month, and then enter the start and end dates.
- Click **Apply** to save the settings, and then **OK** to return to the Edit screen.
- Repeat steps 2 to 5 for other holiday periods.
- Click **Back** to return to live view.

## Manual recording

The DVR lets you manually record video during live view. This can be useful if you know that the DVR is not currently recording and you see something of interest on a camera screen that should be recorded.

Once a manual recording is started, the recording continues until it is manually stopped. If an alarm occurs during a manual recording, the alarm recording has priority over the manual recording. If a scheduled recording is already in progress when a manual recording is started, it continues to record as scheduled.

You can check to see if a camera is recording manually by looking at the icon on the quick access toolbar. The icon is red when manually recording. Default is off.

There are two ways to start and stop a manual recording:

- **Use the quick access toolbar**

You can start/stop manual recording for each camera individually. Position the cursor over a camera image and left-click the mouse to display the quick access toolbar. Click the manual record icon to start or stop manual recording. The icon is red when recording.

- **Use the configuration menu**

This option lets you select more than one camera at a time. Go to Video Schedule > Manual Record to access the manual recording menu and check the boxes of the cameras to start or stop manual recording.

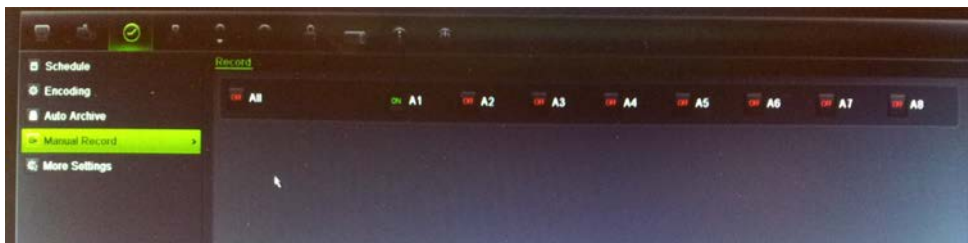

## Motion detection schedules

You can set up both the schedule and areas sensitive to motion detection for each camera individually or easily copy the settings of one camera to other cameras.

For information on scheduling motion detections, see “Motion detection set up” on page 100.

## External alarm schedules

The DVR can be scheduled to record when an alarm is triggered by an external alarm device such as a PIR detector or dry contacts. For information on

scheduling external alarms, see “Triggering or clearing alarm outputs manually” on page 104.

## Protecting recorded files

There are two methods to prevent recorded files from being inadvertently overwritten or deleted off the HDD. We highly recommend that important recorded events be protected from deletion. Recorded files can either be *locked* or the HDD that the files reside on can be set to *read only*.

## Locking and unlocking recorded files

Lock files to protect them against being overwritten or deleted.

### To lock or unlock a recorded file:

1. In live view enter the video search screen by pressing the **Search** button on the front panel or remote control, and then enter Advanced Search.

— Or —

In live view right-click the mouse to display the pop-up menu and select **Advanced Search**.

The Search screen appears.



2. Search for the desired recording by entering the search parameters, which include the camera number, record type, file type, and start time and end time.
3. Click **Search**.

A list of recordings, similar to the figure below, matching the search parameters is displayed.

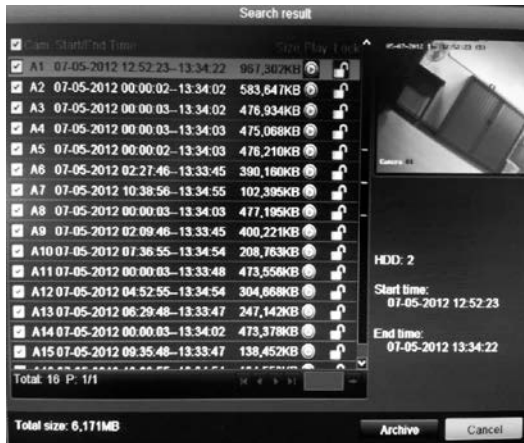

4. Select the file you want to lock/unlock.
5. Click  to lock a file. Click again to unlock.

The Locked column indicates whether a file is locked or not. Closed lock icons indicate locked files while opened lock icons indicate unlocked files. The Lock button toggles between Lock and Unlock, depending on the file.

6. Click **Cancel** to return to live view.

## Setting the HDD to read-only

When you set an HDD to *read-only*, recorded video files cannot be written to the HDD. If multiple HDDs are used, the DVR automatically records to the next HDD not set to *read-only*.

### To set a HDD to read-only:

1. Click the **System Setting** icon in the menu toolbar.
2. Click **Hard Disk** to set up the HDD parameters.
3. Select the HDD you want to set to read-only.
4. Check **Read only**.
5. Click **Apply** to save the settings. The HDD is now read-only.

**Note:** In order to enable recordings on that particular HDD again, you must set the HDD status back to R/W (Read/ Write).

## HDD redundancy

Setting up HDD redundancy lets your DVR redundantly record a copy of the videos onto multiple drives as a safeguard against losing all your files in case of disk failures. This process is also known as *mirroring*. You must have more than one HDD in your DVR to set up HDD redundancy.

Redundancy significantly reduces the storage capability of the HDDs. As a result you need to double your capacity to record video over a given time.

**Note:** You must set the storage mode of the HDD to Group before configuring the redundancy. See “Setting up HDD groups” on page 122 for more information.

**To set up HDD redundancy:**

1. Click the **System Setting** icon in the menu toolbar and select **Hard Disk**.
2. Click the **HDD Information** tab and select the HDD to be used for redundancy and click **Edit**.

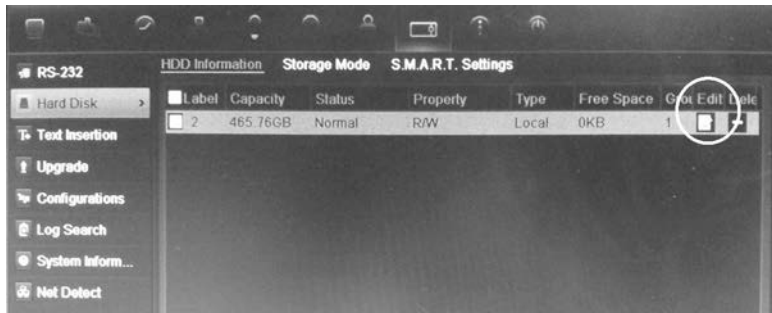

3. In the Local HDD Settings window, select **Redundancy**.  
Verify at least one other HDD is set to R/W (read/write).
4. Click **Apply** to save the settings and then **OK** return to the previous screen.
5. In the menu toolbar, click the **Video Schedule > Encoding**.
6. Select the camera to be used for redundancy.
7. Check **Redundant Record/Capture**.
8. Click **Apply** to save the settings.
9. Repeat steps 7 to 9 for other cameras whose files you would like to be redundantly recorded.
10. Click **Back** to return to live view.

**Note:** The HDD set to redundancy stores an extra copy of the recording. When an HDD is set to redundancy, at least one other HDD must be set to the R/W status.

# Chapter 11

## Alarm settings

This chapter describes setting up how the system will respond when an alarm is triggered.

### Description of alarm notification types

When setting up the rules for alarm detection, you can specify how you want the DVR to notify you about an alarm or event. You can select more than one notification type. Not all notifications types are available for all types of alarms.

Figure 36: Alarm notification types ('Play audio file' option is shown)

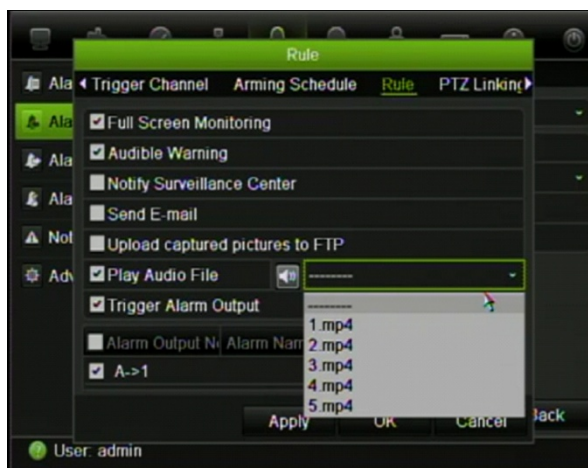

The alarm notification types are:

- **Full screen monitoring:** When an alarm is triggered, the local spot monitor (VGA or BNC monitor) displays an image in live view mode. For alarms that are triggered simultaneously, images display one at a time every 10 seconds (default dwell time). You can set a different dwell time using the Dwell Time setting under the Display Settings>Layout screen. When the alarm stops, cycling of the images stops and you return to live view mode. This alarm option must be selected for each channel where it is required.

- **Audible warning:** Triggers a warning buzzer when an event or alarm is detected by the system or a camera. See “Modifying the warning buzzer” on page 100 for more information.
- **Notify surveillance center:** Sends a signal to TruVision Navigator or other software applications when an alarm or notification is detected.
- **Send e-mail:** Sends an e-mail when an alarm or notification is detected. The e-mail includes an HTML link. Click the link to play the video file showing the alarm or notification. See “Configuring e-mail” on page 112 for information on how to configure the DVR to send an e-mail.
- **Upload captured pictures to FTP:** Sends snapshots to a designated FTP site. See “Configuring an FTP server” on page 115 for more information.
- **Play audio file:** Plays a pre-recorded audio message when an alarm or event is triggered. See “Alarm audio messages” below for more information.
- **Trigger alarm output:** Triggers an alarm output when a notification is detected for an external alarm. See “Setting up external alarms” on page 102 for information on configuring an alarm output.

This alarm notification is not available for system alarms.

- **Panel alarm LED:** Triggers the alarm indicator bar on the front panel to flash on and off when a motion detection alarm is detected. This configuration is located under Display > Monitor > More settings.

## Alarm audio messages

You can record customized audio messages and upload them onto the DVR to be played back when an alarm is triggered. Up to 5 audio files can be stored on the DVR. The message can be up to 20 seconds long and up to 60 kb in file size. Preferred audio file types are MP3 and WAV.

The administrator uploads the audio files onto the DVR using a web browser or an application supported by the SDK. There are sample audio files provided in English:

- An alarm has been triggered. Please leave the premises immediately.
- An alarm has been triggered. The police have been notified.
- These premises are monitored by video surveillance.
- You have entered a restricted area. Please exit this area immediately.

You can use the Player application to convert an MP3 audio to the audio format supported by TVR41. Once converted, you can then upload the file via the browser.



**To import an alarm audio file:**

1. Insert the storage device with the alarm audio file in the DVR.
2. Click the **Alarm** icon in the menu toolbar and select **Alarm Audio**.



**Note:** To modify the name of an audio file, click **Edit** for the desired file and enter the new file name.

3. Click **Import** to import a file. The following screen appears:



4. Under **Device Name**, select the storage device.
5. Under **Import to**, select the audio file number, and then click **Import** to return to the Alarm Audio screen.
6. Click the **Audio Output** tab and select the desired audio output: HDMI, Audio output1 or Audio output2.
7. Click **Import**.

**Note:** Up to 5 audio files can be imported.

**To delete an alarm audio file:**

1. Click the **Alarm** icon in the menu toolbar, and select **Alarm Audio**.
2. Select the file to be deleted, and click **Delete**.

**Note:** There will always be a minimum of five audio files listed.

## Modifying the warning buzzer

When an alarm is triggered by the system or a camera, the DVR can be set up to respond with a warning buzzer. You can modify the time during which the warning buzzer sounds for both system and camera alarm. Select **Alarm > Advanced Settings** and select a buzzer time limit for the system and camera alarms. Default is mute.

## Setting up motion detection

Motion detection is one of the most important features of a DVR. With it there is no need to manually search through hours of video recordings to find an event. The TVR 41 can be set up to trigger an alarm if it detects motion and to record it. You can then search these recorded motion activities for specific incidents. If enabled, motion detection recording can help increase the number of days your DVR can record.

You can mask out any areas of motion on a camera display that you do not want to trigger a recording such as a flag on a pole or a moving tree.

Select the level of sensitivity to motion as well the target size so that only objects that could be of interest can trigger a motion recording. For example, recording is triggered by the movement of a person but not that of a cat.

You can set up both the schedule and areas sensitive to motion detection for each camera individually or easily copy the settings of one camera to other cameras. You can also select a specific audio alarm file to play for a camera or group of cameras.

## Motion detection set up

**To set up motion detection:**

1. Click the **Camera Management** icon in the menu toolbar and select **Motion**.



2. Select the camera to detect motion. Each camera must be set up individually.
3. Check **Enable Motion Detection**.
4. Select the areas sensitive to motion.

Click and drag the mouse cursor across the screen. The area selected appears as a red grid. Areas covered by the red grid are sensitive to motion detection.

Click **Full screen** to activate the whole screen or **Clear** to clear the screen.

**Note:** The motion grid is sensitive to motion during configuration. The grid blocks become red when motion is detected. This real time feedback is available in the OSD, browser, and via the SDK.

5. Set the sensitivity level.

Drag the Sensitivity scroll bar to the desired sensitivity level. The highest value is on the right of the bar.

6. Specify the target size.

In the Target size option, specify how many grid squares must be activated before motion is detected. Enter a value between 0 and 255 squares.

7. Select the cameras that will record the motion detected.

Click **Rule**. The Rule screen appears. Click the **Trigger Channel** tab and select the cameras that will record when a motion alarm is triggered. Click **Apply** to save the settings.



8. Select the recording schedules for motion detection.

Click the **Arming schedule** tab and select the day of the week and the time periods during the day when motion can be recorded. You can schedule up to eight time periods in a day. Default is 24 hours.

Click **Apply** to save the settings. Click **Copy** to copy the settings to other days of the week.

**Note:** Time periods defined cannot overlap.



9. Select the response method to motion detection.

Click the **Rule** tab to define the method by which you want the DVR to notify you of the alarm. More than one notification type can be selected.



If you want one of the pre-recorded audio messages to play when an alarm or event is triggered, check **Play audio file** and select the desired audio file from the drop-down list. Click the siren button to confirm that you have selected the correct audio file.

Click **Apply** to save settings.

10. Click **OK** to return to the motion detection settings screen.

11. Click **Back** to return to live view.

**To trigger the front panel alarm LED:**

1. Click the **Display Settings** icon in the menu toolbar and select **Monitor>More Settings**.
2. Check both the **Other Notification: Panel Alarm LED** and **Motion Alarm** boxes.

## Setting up external alarms

The DVR can be configured to record when an alarm is triggered by an external alarm device (for example, PIR detector, dry contacts...).

**To set up external alarms:**

1. Click the **Alarm settings** icon in the menu toolbar and select **Alarm Input**.

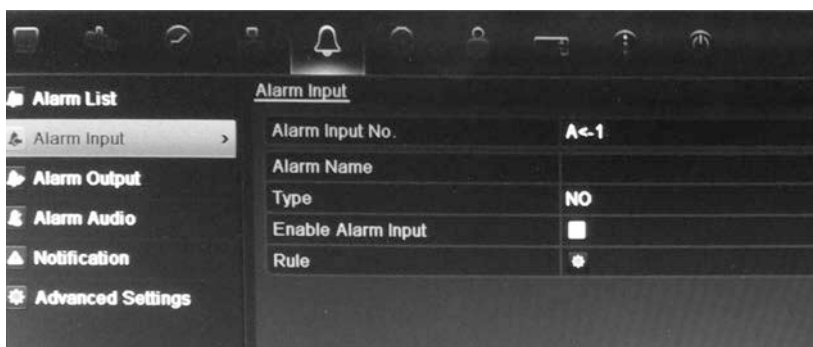

2. Select the alarm input number of a camera, and enter the input name, if required.
3. Select the alarm input type, NO or NC.

4. Check the **Enable Alarm Input** box to enable the function. Click **Rule** to set up the rules for the cameras to be triggered, their alarm schedules, method of alarm notification and PTZ function.
5. Select the cameras to be triggered when an external alarm is detected.

In the Rule window, click **Trigger channel** and select the cameras to be triggered for recording when an alarm is detected. Only analog cameras can be selected. Click **Apply** to save the settings.

6. Select the recording schedules for the external alarm.

Click the **Arming schedule** tab and select the day of the week and the time periods during the day when motion can be recorded. You can schedule up to eight time periods in a day. Default is 24 hours.

Click **Apply** to save the settings. Click **Copy** to copy the settings to other days of the week and holiday period.

**Note:** The time periods defined cannot overlap.

7. Select the response method to an external alarm.

Click the **Rule** tab to define the method by which you want the DVR to notify you of the alarm. Click **Apply** to save settings.



8. Select the PTZ camera function required in response to an external alarm.

Select the PTZ camera and the preset, preset tour or shadow tour that is triggered when the alarm is detected.

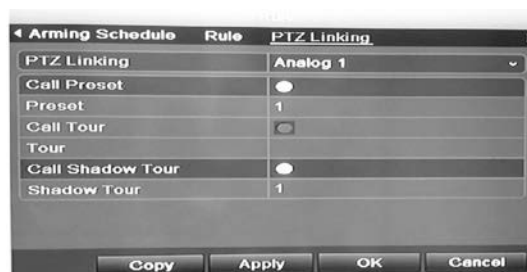

Click **Apply** to save the settings. Click **Copy** to copy the settings to other cameras, if required.

9. Click **OK** to return to the alarm input screen.
10. Click **Back** to return to live view.

**To set up an alarm output:**

1. Click the **Alarm Settings** icon in the menu toolbar and select **Alarm Output**.
2. Select the alarm output.
3. Select a timeout option.

The timeout setting lets you define how long a signal remains active after the alarm has ended. If you select **Manually Clear**, the signal remains active until it is manually acknowledged by pressing the alarm button on the front panel or remote control (see “Triggering or clearing alarm outputs manually” below).

4. Select the recording schedules for the alarm output.

Click **Rule** and select the day of the week and the time periods during the day when motion can be recorded. You can schedule up to eight time periods in a day. Default is 24 hours.

Click **Apply** to save the settings. Click **Copy** to copy the settings to other days of the week and holiday period.

**Note:** The time periods defined cannot overlap.

5. Click **OK** to return to the alarm output screen.
6. Click **Back** to return to live view.

## Triggering or clearing alarm outputs manually

When an alarm is activated, the DVR can be set up so that the alarm must be manually acknowledged in order to be silenced. See “Setting up external alarms” on page 102 for information on setting up an alarm to be manually cleared.

All user levels (administrator, manager and operator) can manually acknowledge an alarm.

**To trigger or clear alarm outputs manually:**

1. Click the **Alarm settings** icon in the menu toolbar and select **Alarm Output**.
2. Click the **Manual Alarm** tab.
3. Select the desired alarm output and click one of the following buttons:
  - **Clear:** Clear to stop alarm output.
  - **Trigger All:** Trigger all alarm outputs at once. This action could be done, for example, when you need to test them.
  - **Clear All:** Stop all alarm outputs at once.
4. Click **Back** to return to live view. The alarm is silenced.

- Or -

1. Press the **Alarm** button on the front panel or remote control. The alarm is silenced.

## Setting up system notifications

Setting up system notifications instructs the DVR to alert you when irregular events occur and how to alert you to the event.

You can quickly check the system status by looking at the status LEDs on the front panel. When there is an irregular event with the system, an icon appears on screen to also alert you. See “Status information” on page 29 for further information.

The system notifications include:

- **HDD Full:** All installed HDDs are full (Overwrite option is disabled).
- **HDD Error:** Errors occurred while files were being written to the HDD, no HDD installed or HDD had failed to initialize.
- **Network Disconnected:** Disconnected network cable.
- **IP Conflicted:** Conflict in IP address setting.
- **Illegal Login:** Wrong user ID or password used.
- **Abnormal Video Signal:** Unstable video signal or video loss detected.
- **Input/output Video Standards Mismatch:** I/O video standards do not match.
- **Abnormal Record:** Recording failed due to encoder or HDD problems.

See “Description of alarm notification types” on page 97 for information on the different alarm notification types available.

### To set up system notifications:

1. Click the **Alarm settings** icon in the menu toolbar and select **Notification**.
2. Select a notification type. See “Description of alarm notification types” on page 97 for more information.
3. Check one or more response options: Full screen monitoring, audible warning, notify surveillance center, send e-mail, upload captured pictures to FTP, play audio file, and trigger alarm output.
4. Click **Apply** to save the settings.

## Detecting video loss

Video may be lost if the video cable or camera develop a fault or are damaged. You can set up the DVR to detect video loss and trigger a system notification.

**To setup video loss detection:**

1. Click the **Camera management** icon in the menu toolbar and select **Video Loss**.
2. Select a camera to configure for video loss detection.
3. Check the **Enable Video Loss Alarm** box to enable the feature.
4. Click **Rules** next to the Video Loss Detection box to enter the Rules screen.
5. Click the **Rule** tab and select how you want the DVR to notify you of video loss. Click **Apply** to save the settings and then click **OK** to return to the previous screen.
6. Click the **Arming Schedule** tab and select the schedule of when you want video loss detection to be enabled. Schedule can be set for all week or any day of the week with up to 8 time periods per day.
7. Click the **Apply** button to save settings.
8. Click **Copy** to copy these settings to other cameras.
9. Click **Back** to return to live view.

## Detecting video tampering

Video tampering, such as moving a camera to a different position, can also be detected and set to trigger an action on the DVR.

**Note:** It is strongly recommended not to configure for video tampering when using PTZ dome cameras.

**To set up video tampering detection:**

1. Click the **Camera management** icon in the menu toolbar and select **Tamper-Proof** to display the tamper-proof settings screen.
2. Select a camera to configure for video loss detection.
3. Check the **Enable Tamper-proof** box to enable the feature.
4. Define a tampering area.
 

The tamper detection area setup interface lets you define an area on screen where you want camera tampering to be detected. Click and drag the mouse across an area to mark that area for video tampering. You can only set one tampering area with the full screen being the maximum area. Click **Clear** to clear the screen.
5. Select the tamper detection sensitivity level by clicking the sensitivity scroll bar. Higher sensitivity is to the right of the bar.
6. Select the recording schedules for the tamper.



Click **Rule** and then select the **Arming schedule** tab to select the day of the week and the time periods during the day when motion can be recorded. You can schedule up to eight time periods in a day. Default is 24 hours.

Click **Apply** to save the settings. Click **Copy** to copy the settings to other days of the week and holiday period.

**Note:** The time periods defined cannot overlap.

7. Select the response method to an external alarm.

Click **Rule** and then select the **Rule** tab to select the method by which you want the DVR to notify you of the alarm. Click **Apply** to save settings and then **OK** to return to the previous screen.

8. Click **Back** to return to live view.



# Chapter 12

## Network settings

You must configure your DVR's network settings before using it over the network. The DVR must have access to the internet when configuring the network settings.

**Note:** As every network configuration may differ, please contact your Network Administrator or ISP to see if your DVR requires specific IP addresses or port numbers.

### Configuring general network settings

To configure general network settings:

1. Click the **Network settings** icon in the menu toolbar to display its screen.



2. Click **General** and enter the required settings:

Option	Description
NIC type	Network interface card (NIC) is a device used to connect the DVR to a network. Select the NIC type used from the drop-down list. Default value is 10/100/1000M self-adaptive.

Option	Description
Enable DHCP	Check this box if you have a DHCP server running and want your DVR to automatically obtain an IP address and other network settings from that server. Default value is Enable.
IPv4 address	Enter the IP address for the DVR. Default value is 192.168.1.82.
IPv4 subnet mask	Enter the subnet mask for your network so the DVR will be recognized within the network. Default value is 255.255.255.0
IPv4 default gateway	Enter the IP address of your network gateway so the DVR will be recognized within the network. This is typically the IP address of your router. Default value is 192.168.1.1
IPv6 address 1	Enter the IPv6 address for the DVR. Default value is fe80::240:3dff:fe7e:926f/64.
IPv6 address 2	Enter the IPv6 address for the DVR.
IPv6 default gateway	Enter the IPv6 address of your network gateway so the DVR will be recognized within the network. This is typically the IP address of your router.
MAC address	Enter the MAC address.
MTU (bytes)	Enter a value between 500 and 9676. Default is 1500.
Preferred DNS server	Enter the preferred domain name server to use with the DVR.
Alternate DNS server	Enter the alternate domain name server to use with the DVR.

3. Click **Apply** to save the settings.

## Configuring PPPoE

You can connect the DVR directly to a DSL modem. To do this, you need to select the PPPoE option in the network settings. Contact your ISP to get the user name and password.

### To configure general network settings:

1. Click the **Network settings** icon in the menu toolbar to display its screen.
2. Click **PPPoE** and check the enable PPPoE box.
3. Enter your user name and password, and confirm the password.
4. Click **Apply** to save the settings.

## Configuring DDNS

A static IP address never changes so you can enter it into the browser or CMS and the DVR network connection will always work with it.

However, if you have a dynamic IP address for your public IP address, it will change every time you connect to the network. Under such situations, you can set up a dynamic domain name system (DDNS) that will link your public IP address to a host name so that you can connect to the DVR with the host name.

There are two ways to set up a DDNS:

- **DynDNS:** Manually create your own host name. You will first need to create a user account using the hosting web site, DynDDNS.org.
- **ezDDNS:** Activate the DDNS auto-detection function to set up a dynamic IP address. The server is set up to assign an available host name to your DVR.

**Figure 37: ezDDNS setup window**



### To set up DDNS:

1. Click the **Network settings** icon in the menu toolbar.
2. Click **DDNS** to display its screen.
3. Check the **Enable DDNS** box to enable the feature.
4. From **DDNS type**, select one of the DDNS types listed:
  - **ezDDNS:** Click the **Get URL** button. The URL address to access the unit is displayed. If no host name is specified, the DDNS will allocate one automatically.
  - **DynDNS:** Enter the server address for DynDNS (i.e. members.dyndns.org). In the DVR domain name field, enter the domain obtained from the DynDNS web site. Then enter the user name and password registered in the DynDNS network.
5. Click **Apply** to save the settings.

## Configuring an NTP server

A Network Time Protocol (NTP) server can also be configured on your DVR to keep the date and time current and accurate.

**Note:** If the device is connected to a public network, you should use a NTP server that has a time synchronization function, such as the server at the National Time Center (IP Address: 210.72.145.44) or europe.ntp.pool.org. If the device is setup in a more customized network, NTP software can be used to establish a NTP server used for time synchronization

### To set up an NTP server:

1. Click the **Network settings** icon in the menu toolbar.
2. Click **NTP** to display its screen.
3. Check the NTP box to enable feature. It is enabled by default.
4. Enter the NTP settings:
  - **Interval:** Time in minutes to synchronize with the NTP server. The value can be between 1 and 10080 minutes. Default is 60 minutes.
  - **NTP server:** IP address of the NTP server.
  - **NTP port:** Port of the NTP server.
5. Click **Apply** to save the settings.

## Configuring e-mail

Your DVR can send e-mail notifications of alarms or notifications through the network. The e-mail includes an HTML link. Click the link to play the video file showing the alarm or notification.

**Note:** Ensure that the DNS address has been set up correctly beforehand.

### To configure e-mail settings:

1. Click the **Network Settings** icon in the menu toolbar.
2. Click **E-mail** and enter the required settings.

Option	Description
Enable server authentication	Check the box if your mail server requires authentication, and enter the login user name and password.
SMTP server	Enter the SMTP server's IP address.
SMTP port	Enter the SMTP port. The default TCP/IP port for SMTP is 25.
Enable SSL	Check the box to enable SSL if it is required by the SMTP server. This feature is optional.
Sender	Enter the name of the sender of the e-mail.
Sender's address	Enter the sender's e-mail address.

Option	Description
Select receivers	Select an e-mail recipient. Up to three receivers can be selected.
Receiver	Enter the name of the receiver of the e-mail.
Receiver's address	Enter the e-mail address of the receiver.
Enable attached snapshot	Check the Attach JPEG File box if you want to send an e-mail with attached alarm images.
Interval	Select an interval range in the Interval box. The interval range represents the time range in between the alarm images being sent. For example, if you set the interval range at two seconds, the second alarm image will be sent two seconds after the first alarm image

3. Click **Test** to the test e-mail settings.

**Note:** We recommend that you test the e-mail settings after entering values in the e-mail window.

4. Click **Apply** to save the settings.

## Configuring UPnP™

The DVR supports UPnP™ (Universal Plug and Play). This feature lets the DVR automatically configure its own port forwarding, if this feature is also enabled in the router.

You can select one of two methods to set up UPnP:

**Automatic mapped type:** The DVR automatically uses the free ports available that were set up in the Network Settings menu.

**Manual mapped type:** You enter the particular external port settings and IP addresses required to connect to the desired router (see Figure 38 on page 114).

Figure 38: UPnP manual configuration screen (browser shown)



**To enable UPnP:**

1. Connect the DVR to the router.

**Note:** The router must support UPnP and this option must be enabled.

2. Click the **Network settings** icon in the menu toolbar.
3. Click **UPnP** and enable the option.



4. From **Mapped Type**, select Auto or Manual.

If Manual is selected, enter the external ports and IP addresses required.

5. Click **Apply**.



## Configuring SNMP

SNMP is a protocol for managing devices on networks. When you enable SNMP in the menu, network management systems can retrieve DVR status information from the DVR via SNMP.

When you set the trap address and trap port in the DVR menu to the network management system's IP address and port number and setup the network management system as trap receiver, trap notifications (such as startup) will be sent from the DVR to the network management system.

Before using this function, you must first install the SNMP software

### To configure SNMP protocol settings:

1. Click the **Network settings** icon in the menu toolbar.
2. Click **SNMP** and enter the required settings.
3. Click **Apply** to save the settings.

## Configuring an FTP server to store snapshots

You can upload your snapshots to an FTP server for storage.

**Note:** It is not possible to stream video to an FTP site.

### To configure the FTP server settings:

1. Click the **Network settings** icon in the menu toolbar.
2. Click **FTP** and check the **Enable FTP** box.
3. Enter the FTP server information.
4. Click **Apply**.

## Configuring a remote alarm host

If a remote alarm host set, the DVR sends a signal to the host when an alarm is triggered. The remote alarm host must have the TruVision Navigator server software installed.

### To set up a remote alarm host:

1. Click the **Network Settings** icon in the menu toolbar.
2. Click **More Settings**.
3. Enter Alarm Host IP and Alarm Host Port.

Alarm host IP represents the IP of the remote PC where the Network Video Surveillance software installed. The alarm host port value must be the same as software's alarm monitor port. Default port is 7200.

## Configuring multicast

Setting up multicasting resolves limitation issues when streaming videos through a network access device. A multicast address spans the Class-D IP range of 224.0.0.0 to 239.255.255.255. We recommend that the IP address range of 239.252.0.0 to 239.255.255.255 be used.

### To set up multicasting:

1. Click **Network Settings** icon in the menu toolbar and then click **More Settings**.
2. Enter a Multicast IP address.

**Note:** When adding a device to the Network Video Surveillance software, the multicast address must be the same as the DVR's multicast IP.

3. Click **Apply** to save the settings.

## Configuring the server and HTTP ports

You can change the server and HTTP ports from the default settings in the Network Settings screen. The default server port is 8000 while that of the default HTTP port is 80.

**Note:** The server port has a port range of 2000 to 65535 and is used for remote client software access. The HTTP port is used for remote internet browser access.

### To change the default ports:

1. Click the **Network Settings** icon in the menu toolbar and then click **More Settings**.
2. Enter the new Com Port and HTTP Port values.

## Configuring the RTSP service port

The RTSP (Real Time Streaming Protocol) is a network control protocol designed for use in entertainment and communications systems to control streaming media servers.

### To configure RTSP service port:

1. Click the **Network Settings** icon in the menu toolbar and then click **More Settings**.
2. Enter the RSTP port value. The default value 554.

## Checking network status

You can easily check network traffic in order to obtain information about the DVR such as its linking status, MTU, sending/receiving rate, MAC address, and NIC type.

You can also check the network connection status by testing its delay and packet loss.

### To check network traffic:

1. Click the **System Settings** icon in the menu toolbar and then click **Net detect** to display the Traffic screen. The information displayed is refreshed once a second.



### To check network delay and packet loss:

1. Click the **System Settings** icon in the menu toolbar and then click **Net detect**.
2. Select the **Network Detection** tab.
3. Under the section "Network delay, Packet loss test", enter the destination address and click **Test**.

The test result appears in a pop-up screen.

4. If you need to check the current network parameters, click the **Network** button to get an overview.

### To check network statistics:

1. Click the **System settings** icon in the menu toolbar and then click **Net detect**.

2. Select the **Network Stat.** tab.
3. The latest information is displayed on the bandwidth used by remote live and playback as well by Net Receive Idle and Net Send Idle. Click **Refresh** to update the information.

## Exporting network packet data

When the DVR is connected to a network, you can export the captured data packet to a, USB-flash disk, SATA/eSATA CD-RW and other local backup devices.

### To export network packet data:

1. Click the **System Settings** icon in the menu toolbar and then click **Net detect**.
2. Select the **Network Detection** tab.
3. Under the section “Network packet export”, click **Refresh** to get a list of the local backup devices available. Select one from the list.
4. Click **Export**. Up to 1M of data can be exported at a time.

## Bandwidth throttle management

The Bandwidth Throttle Management function lets you throttle the amount of network data sent from the DVR to a client. This function is helpful for networks that have predefined bandwidth limits. This feature lets you control the DVR in a network-sensitive environment and prohibits the DVR from sending a large amount of network data that can potentially disrupt the network.

Both live dual streaming and bandwidth throttle management can be used simultaneously or individually. For example, if you display live video in the web browser with the bandwidth throttle management feature enabled, the video update rate is lower, as network video data is sent in shorter, controlled amounts. However, if live dual streaming is enabled, then the video quality increases, since the second stream can be reduced to meet the bandwidth throttle settings, which results in a higher video update rate.

Only the administrator can modify this function.

### To modify the network throttle:

1. Click the **System Settings** icon in the menu toolbar and then click **Net detect**.
2. Select the **Network Stat** tab.



3. Under **Net total limit**, enter a bandwidth limit value. The value can be between 128 Kbps and 80 Mbps, in 1 Kbps increments.
4. Click **Refresh**.



# Chapter 13

## HDD management

### Initializing HDDs

The in-built HDD must be initialized before it can be used. You can also re-initialize the HDD. However, all data on the HDD will be destroyed.

**To initialize a HDD:**

1. Click the **System Settings** icon in the menu toolbar and then click **Hard Disk** to display its screen.
2. Select the HDD to be initialized.
3. Click the **Initialize** button to begin initialization.



After the HDD has been initialized, the status of the HDD changes from Abnormal to Normal.

### Controlling disk space on the HDD

You can allocate the maximum permitted storage and snapshot picture capacities from each camera on a HDD.

1. Click the **System Settings** icon in the menu toolbar and select **Hard Disk**.
2. Click the **Storage mode** tab.
3. Under the Mode option, select **Quota**.

4. Select a camera whose storage capacity you want to change and enter the values in GB for maximum record capacity and maximum picture capacity. The maximum storage capacity of the HDD is listed.
5. Click **Apply** to save the settings.
6. If you want to copy these values to other cameras, click **Copy** and select the cameras. Click **OK**. Click **Apply** to save the settings.

## Setting up HDD groups

Your DVR can organize multiple HDDs into groups. Videos from specified channels can be set to be recorded onto a particular HDD group. You could, for example, save the records from a couple of high priority cameras to one HDD, and save the recordings from all the other cameras to another HDD.

### To set up a HDD group:

1. Click the **System Settings** icon in the menu toolbar and select **Hard Disk**.
2. Select the **Storage Mode** tab.

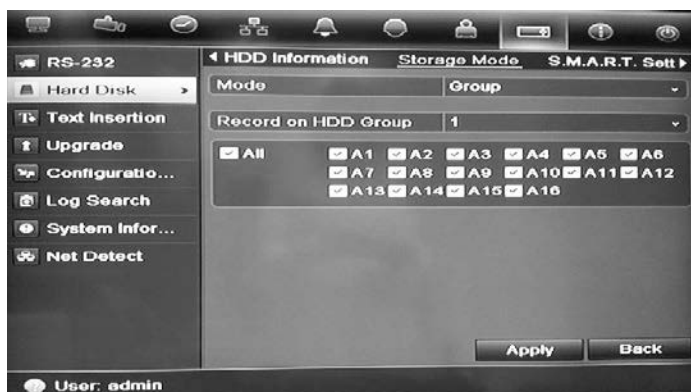

3. Under **Mode**, select **Group**.
4. Under **Record on HDD Group**, select the HDD group number.
5. Check the channels to be added to this group.  
**Note:** By default, all channels belong to HDD group 1.
6. Click **Apply** to save the settings.



## Recording dual streaming

Dual streaming allows high quality video to be recorded in one stream (Normal stream) and lower quality video to be recorded in another stream (Thin stream) that can be easily streamed through a narrow bandwidth.

The normal stream has the frame rate, quality, and resolution as configured in the encoding menu. However, in a thin stream data thinning has been carried out so that it has a lower quality and storage requirements. This allows more video to be recorded on the HDD.

### To record dual streaming:

1. Click the **System** icon in the menu toolbar and select **Hard Disk**.
2. Select the **Storage Mode** tab.
3. Under **Mode**, select **Dual Streaming**.
4. Drag the markers to specify the percentage of the HDD that should be used to store normal recordings (green), thin recordings (blue), and snapshots (pink).

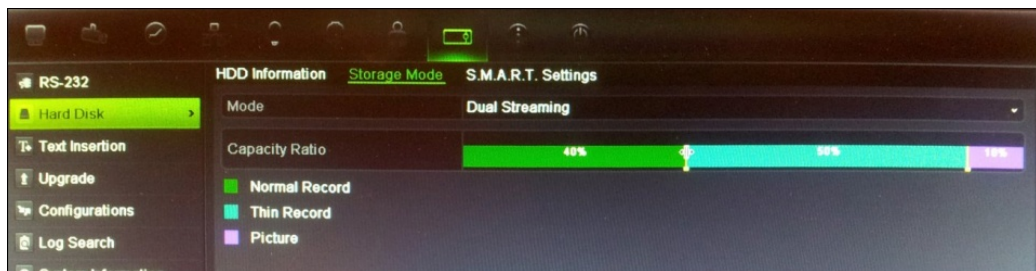

5. Click **Apply** to save the settings.

## Setting the HDD property

You can change the behavior of your HDD by changing its property. It can be set to redundancy, read-only, or read/write (R/W).

A HDD can be set to read-only to avoid important recorded files from being overwritten when the HDD becomes full.

Before changing the HDD property to “Redundancy”, there must be at least two HDDs installed in the DVR, you need to set the storage mode to “Group” and one of the other HDDs must be set to R/W. See “Setting up HDD groups” on page 122 for more information.

### To change a HDD status property:

1. Click the **System Settings** icon in the menu toolbar, and then click **Hard Disk**.
2. Click the **HDD Information** tab.
3. Select the HDD whose property you want to change.

4. Click the **Edit** icon . The Local HDD Settings screen appears.
5. Click the desired HDD property for the selected HDD.
6. Click the group number for this HDD.
7. Click **Apply** to save and exit the screen.

**Note:** Once set to read-only, the HDD cannot be used to save recorded files until it is set back to read/write (R/W). If the HDD that is currently being written to is set to read-only, the data is then recorded to the next HDD. If there is only one HDD present, setting it to read-only means the DVR cannot record.

## Checking HDD status

You can check the status of any of the installed HDDs on the DVR at anytime.

### To check the status of a HDD:

1. Click the **System Settings** icon in the menu toolbar and then click **Hard Disk**.
2. Note the status of the HDDs listed under the Status column.

If the status is listed as Normal or Sleeping, the HDD is in working order. If it is listed as Abnormal and has already been initialized, the HDD needs to be replaced. If the HDD is Uninitialized, you need to initialize it before it can be used in the DVR. Refer to “Initializing HDDs” on page 121 for more information.

**Note:** This information is also available under **System Settings > System Information > HDD** screen.

## Configuring HDD alarms

HDD alarms can be set to trigger when an HDD is uninitialized or in an abnormal state.

### To set HDD alarms:

1. Click the **Alarm settings** icon in the menu toolbar and select **Notification**.
2. Select the notification event to configure under Notification Type box.
3. Select **HDD Full** and check the desired notification method. See “Description of alarm notification types” on page 97 for more information.  
Select **HDD Error** and check the desired notification method.
4. Click **Apply** to save the settings.

## Managing eSATA

If you are using an external e-SATA device connected to the DVR, you can configure the e-SATA to record/capture or export video.

Select the Export option when using the eSATA as a backup. See “Using Quick Archive” on page 65 for further information.

Select the Record/Capture option to record and capture video. Information on the eSATA for this purpose can be seen under **System settings > Hard Drive > HDD Information**.

### To set up the e-SATA device:

1. Click the **Video Schedule** icon in the menu toolbar and select **More Settings**.
2. Under **eSATA**, select the desired option: **Record/Capture** or **Export**.
3. Click **Apply** to save the settings.

## Checking the S.M.A.R.T. information

S.M.A.R.T. (Self-Monitoring, Analysis and Reporting Technology) reports on a variety of hard drive attributes. It helps ensure that the HDD is functioning properly at all times while protecting video stored on the hard drive.

### To view the S.M.A.R.T. information of a HDD:

1. Click the **System Settings** icon in the menu toolbar and then click **Hard Disk**.
2. Select the **S.M.A.R.T.** tab to display its screen.
3. Select the HDD whose data you want to see. A detail listing of S.M.A.R.T. information is displayed.

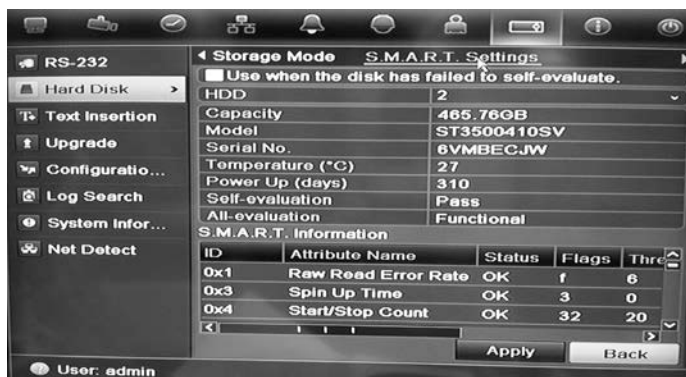

4. If you want to continue to use a HDD when the S.M.A.R.T. test has failed, check the box **Use when the disk has failed to self-evaluate**. Click **Apply** to save the settings.

## Searching video using disk analysis

The DVR can run a disk analysis to get a broader sense of the video data stored on the HDD. This video data can include alarms, events, video Loss, and more.

The disk analysis screen provides a graphical view of the all video stored on the HDD for each camera. The scale is determined dynamically. The timeline flows from left (oldest) to right (newest) video. See Figure 39 below.

Figure 39: Disk analysis screen



1. **Zoom level:** This is the zoom level displayed.
2. **Time/date marker:** This is the date and time of the selected .
3. **Time window:** This represents the time period of the selected zoom level for all the cameras. Events that occurred during this period are indicated on the time bar for each camera. The type of event recorded is color coded.
4. **Change zoom level:** Click the in or out buttons to zoom the analysis view in and out between five levels. The levels are:
  - Level 1: Year view
  - Level 2: Month view
  - Level 3: Day view
  - Level 4: Six-hour view
  - Level 5: One-hour view
5. **Type of event:** Up to five types of event recordings can be displayed: Constant, motion, alarm, manual, and text insertion. Black is no recording.

### To search recorded video using disk analysis

1. In live view, right-click the mouse and in the mouse menu select **Advanced Search > Disk analysis**.
3. Click the **HDD** to analyze and then the **Analyze** button. The disk analysis screen appears.

4. Move the time/date marker to the time period of interest. Click the zoom and out buttons to focus in on the time period for viewing.

**Note:** The playback option is not available.



# Chapter 14

## Camera settings

The TVR 41 can support up to 16 analog cameras.

### Configuring the camera OSD settings

The DVR lets you configure which information is displayed on-screen for each camera. The on-screen display (OSD) settings appear in live view mode and include the camera name, time and date. They also are included in recordings.

You can also adjust the transparency of the OSD relative to the background so that it is easier to read or is less prominent on screen.

**To configure the OSD settings:**

1. Click the **Camera Management** settings icon in the menu toolbar and select **OSD**.



2. Enter a name for the camera, if required.
3. Check the Display Name, Display Date, and Display Week boxes to display the camera name, date, and week.
4. Select a date format and a time format.
5. Select how you want the camera information displayed.

Select one of the options from the drop-down list. Default is non-transparent/non-flashing.

- Transparent & flashing
- Transparent & not flashing

- Non-transparent & flashing
  - Non-transparent & non-flashing
6. There are two text boxes in the camera view screen; one for the camera name (yellow box) and the other for the date/time (red box). Using the mouse, click and drag a text box to the desired position.
  7. To copy the settings to other cameras, click **Copy** and select the desired cameras. Click **OK**.
  8. Click **Apply** to save the settings and then **Back** to return to live view.

## Setting up privacy masking

You can define an area on screen to remain hidden from view. For example, you can choose to block the view of a camera when overlooking residential premises. This hidden area is referred to as privacy masking. Privacy masking cannot be viewed in live view or recorded mode, and appears as a blank area on the video image.

### To setup a privacy mask:

1. Click the **Camera Management** icon in the menu toolbar and select **Privacy mask**.
2. Select the camera for which to set up privacy masking.
3. Check the **Enable Privacy Mask** box to enable the feature.
4. Set up the mask area. Up to four areas can be set.

Using the mouse, click and drag a privacy-mask box in the camera view screen over the desired area. You can set up to four areas for privacy masking. Masked areas are dimmed and outlined in four different colors. Click **Apply** to save settings.

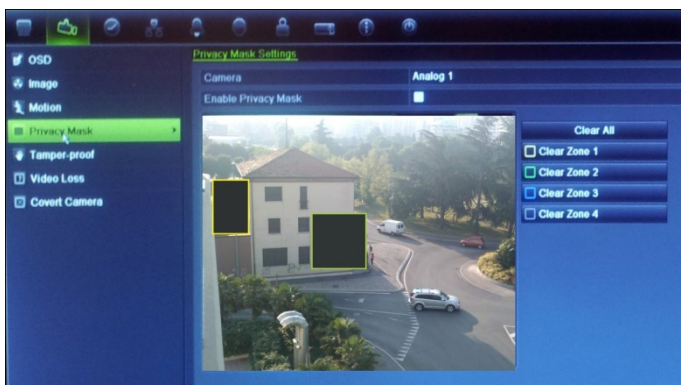

To delete a mask, check the desired mask and click **Clear** for that color mask.

5. To copy the settings to other cameras, click **Copy** and select the desired cameras. Click **OK**.
6. Click **Apply** to save the settings and then click **Back** to return to live view.



## Adjusting camera image settings

You may need to adjust the camera image depending on the location background in order to get the best image quality.

The system has four preset mode settings for frequently encountered lighting conditions; Standard, Indoor, Low light and Outdoor. However, you can also manually adjust the brightness, saturation, contrast, and hue values using the Customize option. Adjustments to the settings affect both live view and recorded images.

**Note:** These options can also be modified from the image settings button on the live view quick access toolbar (see “Accessing frequently used commands” on page 34.)

### To adjust display settings:

1. Click the **Camera Management** icon in the menu toolbar and select **Image**.
2. Select the camera for which to adjust the video image settings.
3. Select the desired mode value. Changes are seen immediately on screen.

If “Customize” is selected, adjust the brightness, saturation, contrast, and hue values by dragging each scroll bar.

4. Click **Apply** to save the settings and then click **Back** to return to live view.

## Hiding a camera image from view

There may be occasions when you want to control who can see a camera image on a local monitor, such as if there is a camera located in a changing room. The DVR lets you select which camera (or cameras) is not displayed on the local monitor unless the user is logged in and has permission to view the camera images. A covert camera is not displayed on screen when no user is logged in. Instead a person walking by sees a black screen with the Interlogix logo. See Figure 40 below.

Figure 40: Example of a covert camera image



**To set up a camera for covert view:**

1. Click the **Camera Management** icon in the menu toolbar and select **Covert camera**.
2. Check which camera or cameras you want to be covert and click **Apply**.

# Chapter 15

## DVR management

This chapter describes:

- Configuring the RS-232 port
- Updating system firmware
- Restoring default settings
- Viewing system information
- Viewing system logs

### Configuring the RS-232 port

Use the System Settings menu to configure the RS-232 parameters such as baud rate, data bit, stop bit, parity, flow control, and usage.

Figure 41: RS-232 setup window



There are three ways the RS-232 port can be used:

- **ProBridge:** POS and ATM text insertion supported via the ProBridge accessory connected to the RS-232 port. See “Capturing text insertions” on page 81 for more information.
- **ATS/Challenger:** NTP time sync supported to foreign device over the RS-232 port.

- **Technical support:** Console mode.

## Updating system firmware

The firmware on the DVR can be updated using five methods:

- Via an USB device
- Over the network via an FTP server
- Via the DVR web browser
- Using TruVision Navigator. For further information, refer to the TruVision Navigator user manual
- Via an optical drive

The firmware upgrade file is labeled *TVR41.dav*.

### To update the system firmware using a USB device:

1. Download on to a USB the latest firmware from our web site at:  
[www.gesecurityproducts.eu/videoupgrades](http://www.gesecurityproducts.eu/videoupgrades)  
- Or -  
[www.utcssecurityproductspages.eu/videoupgrades](http://www.utcssecurityproductspages.eu/videoupgrades)
2. Connect the USB device to the DVR.
3. Click the **System Settings** icon in the menu toolbar.
4. Select **Upgrade > Local Upgrade**. The list of files on the USB is displayed.



5. Select the file and click **Upgrade**. Click **Yes** to begin the upgrade process.
6. When the upgrade process is completed, reboot the DVR.

### To update the system firmware via the web browser:

1. Click the **Configuration** tab in the browser toolbar and then select **Maintenance**.

2. For the latest firmware from our web site, download the file at:

<http://www.interlogix.com/library>

- Or -

[www.utcssecurityproductspages.eu/videoupgrades](http://www.utcssecurityproductspages.eu/videoupgrades)

3. Click **Upgrade**.

**Note:** The upgrade process may take up to 10 minutes. The system will automatically reboot once the upgrade is completed.

#### **To update the system firmware via a FTP server:**

For engineering purposes only.

## Restoring default settings

#### **To restore the default factory settings of the DVR:**

1. Click the **System Settings** icon in the menu toolbar and select **Configuration**.
2. Click the **Default** tab.
3. Select one of the following options:

**Default:** Reset all parameters to the factory default settings.

**Restore:** Reset all parameters, except the network information settings, to the factory default settings. Network information includes the IP address, subnet mask, gateway, MTU, NIC working mode, server port and default route.

4. The system immediately starts to restore the settings.

# Viewing system information

To view system information:

1. Click the **System Settings** icon in the menu toolbar and select **System Information**.
2. To view device information, click the **Device Info** tab.
3. To view camera information, click the **camera** tab.



4. To view record information, click the **Record** tab.



5. To view alarm information, click the **Alarm** tab.

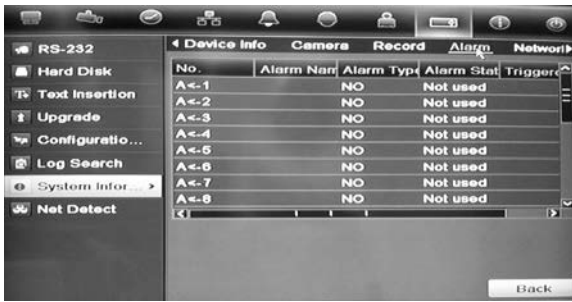

6. To view network information, click the **Network** tab.



7. To view HDD information, click the **HDD** tab.

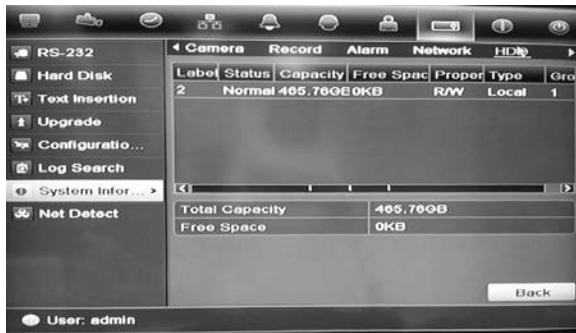

8. Click **Back** to return to live view.

## Searching system logs for events

Many events of the DVR, such as operation, alarm and notification, are logged into the system logs. They can be viewed and exported at any time.

Up to 2000 log files can be viewed at once.



Log files can also be exported onto a USB device. The exported file is named according to the time it was exported. For example: *20120729124841logBack.txt*.

**Note:** Connect the backup device, such as a USB flash drive, to the DVR before commencing the log search.

### To search and export log files:

1. Click the **System Settings** icon in the menu toolbar and select **Log search**.
2. Enter the search parameters and click **Search** to begin the search. The logs matching the search criteria are displayed.



3. To view more detail information about a particular log entry, select the entry and click  or double-click the log entry.
5. If available, you can also view the associated video to the selected log entry by clicking its play button .
5. To export a log entry, select a log and click **Export**.
4. Click **Back** to return to live view.

## Importing and exporting configuration settings

You can export and import configuration settings from a TVR 41. This is useful if you want to copy the configuration settings to another TVR 41, or if you want to make a back up of the settings.

Insert a USB flash drive in the DVR. Use the **System Settings > Configuration** screen to import or export configuration settings. Click **Export Config** to export the DVR's configuration settings into a configuration file. Click **Import Config** to import configuration settings.



# Chapter 16

## User management

By default the DVR comes with three user accounts: an Administrator account, an Operator account and a Guest account. These accounts provide multiple levels of access and functionality. See Table 18 below for a description of the different user accounts.

**Table 18: User accounts**

User	Description
<b>Administrator</b>	The administrator account includes extended menu with full access to all settings. The Administrator has the authority to add, delete or configure parameters for many of the system functions. There can only be one administrator. The user name is admin. The name cannot be modified. The default password is 1234.
<b>Operator</b>	The operator account includes reduced menu access to Video settings (inaccessible features are not visible). The default user name is "operator". The default password is 2222.
<b>Guest</b>	The guest account includes menu access with no programming possibilities (inaccessible features are not visible). The default user name is "guest". The default password is 3333.

**Note:** The default passwords should be changed for security reasons.

### Adding a new user

Only a system administrator can create a user. You can add up to 31 new users. The access privileges of Operator and Guest users are predefined and cannot be modified

**To add new users:**

1. Click the **User Management** icon in the menu toolbar to display its screen.
2. Click **Add** to enter the Add User screen.
3. Enter the new user's name and password. Both the user name and password can have up to 16 alphanumeric characters.
4. Select the new user's access level: Operator or Guest.
5. Enter the user's MAC address to let the user access the DVR from a remote computer with this MAC address.
6. Click **Apply** to save the settings and **OK** to return to the previous screen.
7. Define the user's permissions.

Click the Permission button  for the new user. In the Permissions pop-up screen check the required access privileges for local, remote and camera configuration. See "Customizing a user's access privileges" below for the permission descriptions for each group.

Click **Apply** to save the settings and **OK** to return to the previous screen.

8. Click **Back** to return to live view.

## Customizing a user's access privileges

Only an administrator can allocate access privileges to Operator and Guest users. The access privileges can be customized for each user's needs. The administrator's access privileges cannot be changed.

There are three types of privilege settings: Local Configuration, Remote Configuration, and Camera Configuration.

**Note:** Only the administrator can restore factory default settings.

### Local configuration settings:

- **Local Log Search:** Search and view logs of the DVR.
- **Local Parameter Settings:** Configure parameters. You can also import/export the configuration from the DVR.
- **Local Advanced Operation:** Access HDD management (including the initialization and modification of disk properties). Update system firmware as well as stop the I/O alarm output.
- **Local Shutdown/Reboot:** Shutdown or reboot the DVR.

**Remote configuration settings:**

- **Remote Log Search:** Remotely view logs that are saved on the DVR.
- **Remote Parameter Settings:** Remotely configure parameters and import/export configuration.
- **Remote Camera Management:** Remotely enable and disable channels.
- **Remote Serial Port Control:** For future use.
- **Two-Way Audio:** Use two-way radio between the remote client and the DVR.
- **Remote Alarm Control:** Remotely alert or control the relay output of the DVR. Alarm and notification settings must be configured properly to upload to host.
- **Remote Advanced Operation:** Remotely manage HDDs (initializing and setting properties for HDDs) as well as remotely update system firmware, and clear the I/O alarm output.
- **Remote Shutdown/Reboot:** Remotely shutdown or reboot the DVR.

**Camera configuration settings:**

By default, all analog cameras are enabled for operators for each of these settings and none for guests.

- **Remote Live View:** Select and view live video over the network.
- **Local Manual Operation:** Locally start/stop manual recording on any of the channels, snapshots and video clips.
- **Local Playback:** Locally play recorded files that are on the DVR.
- **Remote Playback:** Remotely play and download recorded files that are on the DVR.
- **Remote PTZ Control:** Remotely control PTZ dome cameras.
- **Local Backup:** Locally back up recorded files from any of the channels.

**To customize a user's access privileges:**

1. Click the **User Management** icon in the menu toolbar to display its screen.
2. Click the Permission button  for the user whose access privileges need to be changed. The Permissions pop-up screen appears.
3. Click **Apply** to save the settings.
4. Click the **OK** button to return to the previous screen.
8. Click **Back** to return to live view.

## Deleting a user

Only a system administrator can delete a user.

### To delete a user from the DVR:

1. Click the **User Management** icon in the menu toolbar to display its screen.
2. Click the **Delete** button  for the user to be deleted.
3. Click **Yes** in the pop-up screen to confirm deletion. The user is immediately deleted.
4. Click **Back** to return to live view.

## Modifying a user

A user's name, password, access level and MAC address can be changed. Only a system administrator can modify a user.

### To modify a user:

1. Click the **User Management** icon in the menu toolbar to display its screen.
2. Click the **Edit** button  for the user whose access privileges need to be changed. The Edit User pop-up screen appears.
3. Edit the user information and click **Apply** to save the settings. .
4. Click the **OK** button to return to the previous screen.
5. Click **Back** to return to live view.

## Changing the Admin password

The administrator's password can be changed in the **User Management** menu. Click the **Change Password** tab and enter the new information. The administrator's MAC address can be changed here too. Once completed, click **Apply** to save the settings.

# Chapter 17

## iTVRmobile

You can easily log on to the TVR 41 using the TruVision iTVRmobile application. Once installed on your iPhone, it can be used over a wireless network to remotely view live video from DVRs, PTZ cameras and DVSs. It can also be used to control PTZ cameras.

For detailed information on setting up and using the iTVRmobile application, please refer to the iTVRmobile user manual.

### Setup and login

Download the **TruVision TVRmobile** application from the iTunes Store to your iPhone. The iTVRmobile appears on the iPhone home page:

**Figure 42: iTVRmobile application icon**

---

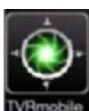

You need to register an administrator when using this application for the first time. Enter the user name and password in the register interface and click **Register** to complete user registration.

The next time the application is used, the user name of the last user is displayed by default. When logging in, you also can enable **Auto Login** so that the application will automatically login next time.

Once logged in, the iTVRmobile main menu appears. See Figure 43 below for further information.

Figure 43: Main menu description



Live	Live view mode and PTZ control.
Devices	Manage devices such as add a new device, delete a device, display information about the device.
Favorites	Define specific cameras as your favorites so that you can quickly jump to them.
Local Config	Configure the speed of PTZ control and auto login setup.
Account Setting	Password modification.
Help	Help information.
About	Software version.





## Live view

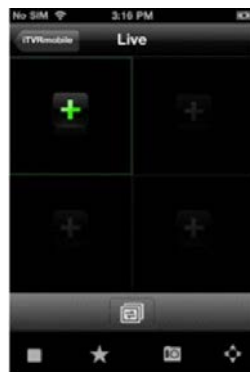

Tap the iTVRmobile icon on the iPhone home page to open the application. Enter your user password, if requested. See Figure 44 for a description of the live view interface.

Figure 44: Live view and toolbar icons





The selected video tile is highlighted by a green frame



Button	Description
	Tap to return to the main menu. <b>Note:</b> This option is only available when in the iPhone is held in portrait orientation.
	This icon appears when there is no camera connected. Tap the cross to obtain the <b>Select Channel</b> screen and select a camera for live view from the list of devices.
	Tap to change the camera in the selected video tile. If there are already four video tiles open in multiview, the next camera selected will replace the camera that was first opened.
	<b>Stop:</b> Tap to stop live streaming of video from the selected camera.

Button	Description
	<b>Bookmark:</b> Tap to create bookmarks. Bookmarks are groups of cameras that can be accessed together.
	<b>Snapshot:</b> Tap to take a snapshot of the live view images.
	<b>PTZ control:</b> Tap to call up the PTZ control arrows on-screen for PTZ control.

### To access live view:

1. In the main menu, tap **Live** to access live view. Live view is in 2X2 multiview mode by default. The selected video tile has a green frame.
2. Double-tap  or  to open the list of devices, bookmarks and favorites available and select the desired camera.
3. Tap the desired device, such as a DVR. All cameras listed under this device are shown.
4. Tap the desired camera in the list. The live view immediately appears on-screen. By default it occupies one of the four video tiles.
5. To display another camera in live view, double-tap  or  again and select the desired camera from the list. Repeat for the other two video tiles, if required.
6. To stop live view for a selected camera, select a camera. The selected camera has a green frame. Tap . A green cross appears in the video tile.
7. To return to the main menu, tap **iTVRmobile**.

Live view from the camera is not disconnected. You can, for example, change configuration settings and then return to live view by tapping  again. The application returns to the live view of the selected camera.

## Controlling a PTZ camera

The application supports main and substream in live view. Substream is default. When selecting the main stream option in live view, please refer to the table below for the recommended parameter settings:

**Table 19: Main stream recommended parameters**

Resolution	Frame rate	Bit rate
XVGA	1 fps	320 Kbps
HD900	1 fps	320 Kbps
720P	1 fps	320 Kbps

Resolution	Frame rate	Bit rate
UXGA	1 fps	320 Kbps
1080P	1 fps	320 Kbps
SVGA	4 fps	320 Kbps
VGA	4 fps	320 Kbps
4CIF	6 fps	512 Kbps
CIF	Max.	320 Kbps
DCIF	15 fps	512 Kbps
2CIF	Max.	512 Kbps
QCIF	Max.	320 Kbps



### To control a PTZ camera:

1. In the main menu, tap **Live** to access live view.
2. Tap  to call up the PTZ toolbar and on-screen arrows.



3. Drag your finger across the on-screen arrows to carefully position the camera in the desired preset location.

 PTZ up
  PTZ down
  PTZ left
  PTZ right

4. To call up a preset position, tap  to bring up the Call/Set screen. Enter a preset number and tap **Call**. The camera moves to the preprogrammed position. Tap  again to exit the preset configuration screen.
5. To zoom in and out of the selected camera image, pinch the screen to zoom in or out. This option is only available for PTZ cameras.
6. To adjust the brightness of the camera image, tap the iris icon  to open the iris scrubber bar. Drag the playhead along the scrubber bar to adjust the image brightness.

## Device management

The device list is empty by default. You must first add the required devices to the iTVRmobile device list before you can access them.



**Note:** Up to 16 devices can be added to the application.

**To add a new device:**

1. In the main menu, tap **Devices**. The Devices page appears. All devices already added to the app are listed.
2. Tap **Add**. The New Device page appears.
3. Enter the following information:
  - Device name:** Enter the name of the device to be linked, such as a TruVision DVR or TruVision cameras. The name can have up to 16 alphanumeric characters.
  - Register mode:** Select either IP or DDNS. Use DDNS when there is no fixed IP address available.
  - Address:** Enter the IP or dynamic name address of the device.
  - Port:** Enter the com port address of the device. For example, 8000 (default).
  - User name:** Enter the device's user name. It can have up to 16 alphanumeric characters.
  - Password:** Enter the device's password.
  - Chan. no.:** Enter the number of cameras to be linked.
4. Tap **Save** to save the settings. The device is added to the device list.
5. In the Device page, tap **Add** again to add another device to the application or tap **iTVRmobile** to exit and return to the main menu.

**To modify or delete a device:**

1. In the main menu, tap **Devices**. The Devices page appears. All devices already added to the app are listed.
2. To modify the parameters of a device: Tap  next to the selected device to be modified. The list of parameters that can be modified appears. Tap **Edit**. Tap the parameter to be modified and enter the new value using the keypad. Tap **Done** and then **Save** to save the changes or **Cancel** to abort and return to the Devices Detail screen.
3. To delete a device: Swipe your finger across the device to be deleted in the list. The Delete button appears. Tap **Delete**.
4. Tap **iTVRmobile** to exit and return to the main menu.

## Favorites

Use the **Favorites** menu to manage frequently used cameras and bookmarks in live view.

Tap and navigate to 'Channels'->'MENU'->'ADD' to go to the Favorites interface. Tap the device to display the cameras list. Select any camera to add to your favorites list by selecting it.

To delete an item in Favorites, in the main menu tap and navigate to 'Bookmarks' or 'Channels'. The list of cameras or bookmarks appears. Tap the "Delete" button to delete it.

## Local configuration

Use the **Local Config** menu to modify the speed of the pan and tilt movement of PTZ cameras as well as to enable/disable automatic login using the current user next time the application is used.

## Change passwords

Use the **Account Setting** menu to modify your current password. Enter the old password, the new password and then confirm new password to complete the change.

## Snapshots

The snapshot pictures are automatically saved in the Photos application.

# Appendix A

## Specifications

	TVR 4104	TVR 4108	TVR 4116
<b>Video &amp; audio input</b>			
Video compression	H.264		
Analog video input	4-ch, BNC (1.0 Vp-p, 75 Ω), PAL /NTSC self- adaptive	8-ch, BNC (1.0 Vp-p, 75 Ω), PAL /NTSC self- adaptive	16-ch, BNC (1.0 Vp-p, 75 Ω), PAL /NTSC self- adaptive
Audio compression	OggVorbis		
Audio input	4-ch, BNC (2.0 Vp-p, 75 Ω)	8-ch, BNC (2.0 Vp-p, 75 Ω)	16-ch, BNC (2.0 Vp-p, 75 Ω)
Two-way audio	1-ch, BNC (2.0 Vp-p, 1 kΩ)		
<b>Video &amp; audio output</b>			
HDMI output	1-ch, Resolution: 1920 × 1080P / 60 Hz, 1920 × 1080P / 50 Hz, 1600 × 1200 / 60 Hz, 1280 × 1024 / 60 Hz, 1280 × 720 / 60 Hz, 1024 × 768 / 60 Hz		
VGA output	1-ch, Resolution: 1920 × 1080P / 60 Hz, 1600 × 1200 / 60 Hz, 1280 × 1024 / 60 Hz, 1280 × 720 / 60 Hz, 1024 × 768 / 60 Hz		
CVBS output	1-ch, BNC (1.0 Vp-p, 75 Ω), Resolution: PAL: 704 × 576; NTSC: 704 × 480		
Video spot output	1-ch, BNC (1.0 Vp-p, 75 Ω), Resolution: PAL: 704 × 576; NTSC: 704 × 480		
Video loop output	4-ch	8-ch	16-ch
Encoding resolution	4CIF / 2CIF / CIF / QCIF		
Frame rate	25 fps (PAL) / 30 fps (NTSC)		
Video bit rate	32 to 4096 Kbps, or user defined (max. 4096 Kbps)		
Audio output	2-ch, BNC (Linear, 600 Ω)		
Audio bit rate	16 Kbps		

	TVR 4104	TVR 4108	TVR 4116
Dual-stream	Support   (Sub-stream at CIF/QCIF: 25 fps (PAL) / 30 fps (NTSC))		
Stream type	Video, Video & Audio		
Playback resolution	4CIF / 2CIF / CIF / QCIF		
Synchronous playback	4-ch	8-ch	16-ch
<b>Hard disk</b>			
SATA	6 SATA interfaces		
e-SATA	1 e-SATA interface		
Capacity	Up to 2TB capacity for each disk		
<b>External interface</b>			
Network interface	1 RJ45 10M / 100M / 1000M Ethernet interface		
Serial interface	1 RS-232 interface (for ProBridge, Challenger, Technical Support); 1 RS-485 interface (for PTZ control); 1 RS-485 keyboard interface (for KTD405 keyboard control)		
USB interface	2, USB 2.0		
Alarm in	16	16	16
Alarm out	4	4	4
<b>Miscellaneous</b>			
Power supply	100 to 240 VAC, 6.3 A, 50 to 60 Hz		
Power consumption (without HDD or DVD-R/W)	≤ 35 W	≤ 40 W	≤ 45 W
Operating temperature	-10 to +55 °C (14 to 131 °F)		
Relative humidity	10 to 90%		
Chassis	19-inch rack-mounted 2U chassis		
Dimensions (W x H x D)	445 x 470 x 90 mm (17.5 x 18.5 x 3.5 in.)		
Weight	≤ 8 kg (17.6 lb.) (without HDD or DVD-R/W)		

# Appendix B

## PTZ protocols

Interlogix-485	PHILIPS
Interlogix-422	PHILIPS-3
Kalatel	SAE
DSCP	Samsung
HIKVISION	Siemens
Honeywell	SONY-EVI-D30/31
INFINOVA	SONY-EVI-D70
KTD-348	SONY-EVI-D100/P
LG MULTIX	TECHWIN
LILIN	VICON
PANASONIC_CS850	YOULI
PELCO-D	
PELCO-P	



# Appendix C

## Port forwarding information

A router is a device that lets you share your internet connection between multiple computers. Most routers will not allow incoming traffic to the device unless you have configured them to forward the necessary ports to that device. By default our software and devices (DVRs and NVRs) require the following ports to be forwarded:

**Note:** Port forwarding may reduce the security of the computers on your network. Please contact your network administrator or a qualified network technician for further information.

**Table 20: Description of the ports**

Port	Port name	Description
80	HTTP protocol	Used to connect via IE browser.
8000	Client Software Port	Used to connect to video streams.
554	RTSP Port	Real time streaming protocol. Used to record video remotely.
1024	RTSP Port for 3G/4G	Use with mobile apps. Used for 3G/4G connection.

**Note:** It is recommended that the RTSP port 1024 should only be used when experiencing connection issues over a 3G/4G connection.

**For example:** If the client port is changed to 9000 then the +200 port will be 9200. Using the default client port 8000 then the +200 port will be 8200.

## Seeking further assistance

Third-party assistance on configuring popular routers can be found at:

<http://www.portforward.com/>

<http://canyouseeme.org/>

<http://yougetsignal.com>

**Note:** These links are not affiliated with nor supported by Interlogix technical support.

Many router manufacturers also offer guides on their websites as well as including documentation with the product.

On most routers the brand and model number is located on or near the serial number sticker on the bottom of the device.

If you cannot find any information for your particular router, please contact your router manufacturer or internet service provider for further assistance.



# Appendix D

## KTD-405 keypad

### Supported firmware

TVR 41XX-YYY firmware	2.0.d or higher
KTD-405U (-2DU) keypad firmware:	1.4.00

**Note:** XX represents the number of video channels

YYY represents the DVR storage configuration such as 1T = 1 TB, etc.

### Wiring the keypad

Connect the RS-485 bus of the KTD-405 I/O box to the TVR 41 Keypab A/B screw terminal port.

**Table 21: Keypad and DVR connections**

KTD-405 I/O box	TVR 41 connection
RS-485 A	Keyb A
RS-485 B	Keyb B

Figure 45: Keypad and DVR connections

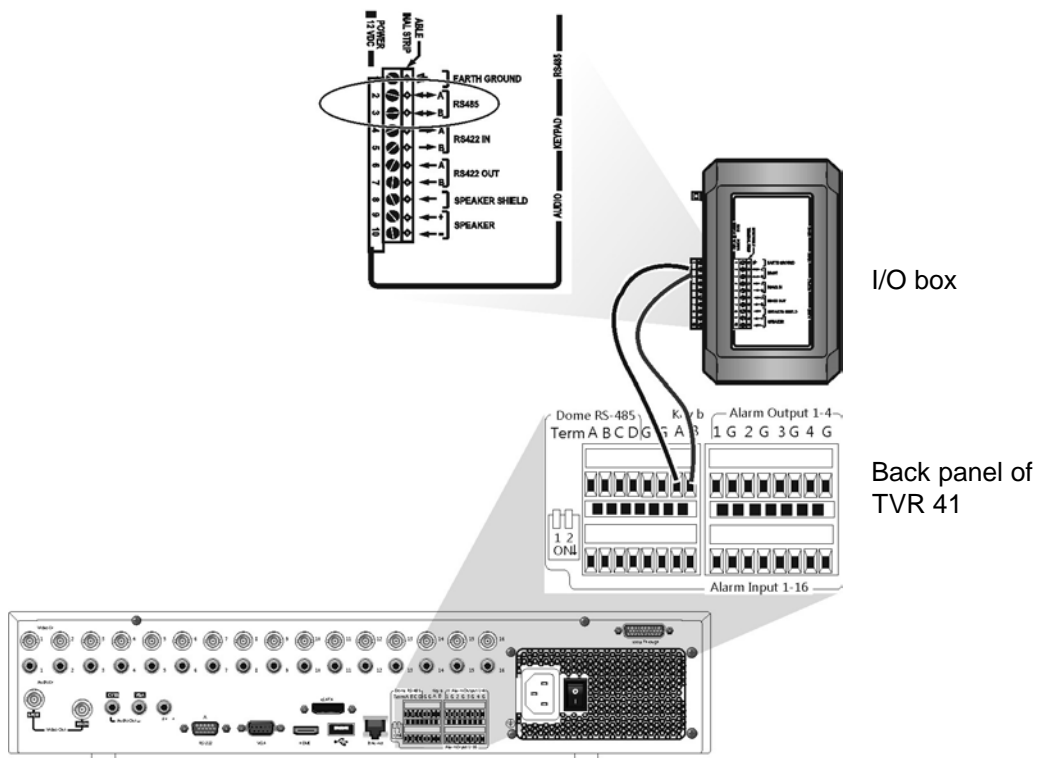

## Setting up the keypad to work with the TVR 41

The keypad must be in zone mode to connect correctly with the TVR 41.

Further information on connecting and programming the KTD-405 keypad can be found in the user manual.

### To set the keypad in zone mode:

1. Log into the keypad using the Admin password. Hold down the Enter button (↵) until a beep sounds and then enter the following code: **1 4 7 6**. Push the **seq** button to confirm.
2. Scroll through the menus with the **▶** button until this menu appears:

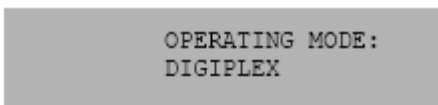

3. Change *Operating Mode* to *Zone* by moving the joystick down.
4. Quit the menu by pressing the **seq** button. The display will show, for example:

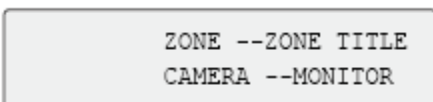

5. To connect it to the DVR, press the **zone** button and enter the ID number of the TVR 41. The default value is “1”.
6. To configure the DVR zone ID number, at the DVR enter the **Monitor** screen by selecting **Display Mode Settings** in the main menu, and then select Monitor. Under Zone ID, enter the zone ID value. The default value is “1”.

**Note:** The zone ID value must be identical for the DVR and keypad.

The TVR 41 is now connected to the KTD-405 keypad.

## TVR 41 and keypad functions

The KTD-405U acts as a DVR control keypad when connected to the TVR 41. The keypad mimics many of the functions available from the front panel of the TVR 41.

### Unavailable TVR 41 functions

The following TVR 41 functions are unavailable when using the keypad to control the TVR 41:

- Export video
- Shadow tour
- Select motion detection or tampering zones
- Archive records
- Capture video

If these functions are required, it is recommended to use a mouse in conjunction with the keypad as all TVR 41 functions will then be available.

### Unavailable keypad functions

The following keypad buttons are unavailable when using the keypad to control the TVR 41:

**Figure 46: Unavailable keypad buttons**

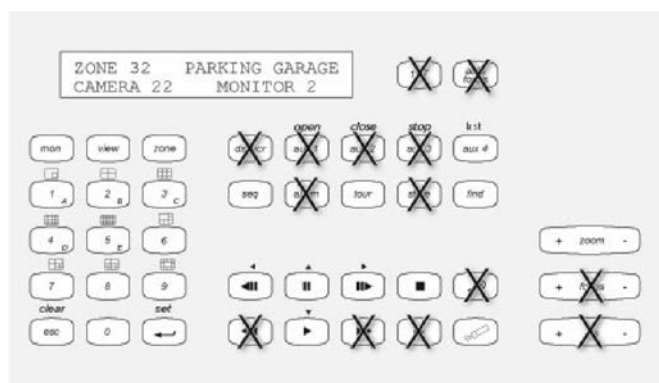









DSC/VCR	Autofocus	● (Record mode)
Aux 1	Alarm	Store
Aux 2	Iris +/-	▶▶ Fast forward
Aux 3	Focus +/-	◀◀ Fast backward
Aux 4	 (Magnification)	
Ist		

## Operating the keypad



You can navigate the TVR 41 menus using the keypad buttons and joystick. However, not all maneuvers are available using the joystick.



See Table 22 on page 159 for the description of the DVR keypad mapping when using the KTD-405 keypad series. See Figure 46 above for a list of the keypad functions that are unavailable when connected to the TVR 41

### Example 1: To enter your password in the login screen using the keypad

1. In live view mode, press **esc** to activate the Login screen.
2. Press and hold **esc** and then press the arrow buttons ( **down**,  **up**,  **left**,  **right**) to move the cursor to the Password edit box. Once in the password box, release **esc**.
3. Press **Enter** () to activate the virtual keyboard.
4. Press and hold **esc** and then press the arrow buttons to reach the first digit of the password. Release **esc** and press **Enter** () to select the digit.  
Or move the joystick to the first digit of the password and press **Enter** ()
5. Repeat steps 2 to 4 for each digit of the password.
6. Move the cursor to the Enter button on the virtual keyboard and press **esc** on the KTD-405 keypad to enter the password.
7. Press and hold **esc** and then press the arrow buttons to navigate the cursor to activate OK button on the Login screen.
8. Press . The main menu appears.

### Example 2: To modify a menu option using the keypad











1. In the main menu press and hold **esc** and then press the arrow buttons to navigate to the desired menu icon (for example, Display Mode Settings).
2. Press  to enter **Display Mode Settings** menu.
3. Press **Zoom +** or **Zoom -** to scroll to the menu tab, **More Settings**.
4. When in the desired menu screen, press and hold **esc** and then press the arrow buttons ( **up**,  **down**) to navigate the cursor to the option, **Menu Timeout**.





5. Press  to activate the dropdown menu.
6. Press and hold **esc** and then press the up/down arrow buttons to navigate to the desired option.
7. Press  to select the option.
8. Press and hold **esc** and then press the up/down arrow buttons to navigate to Apply. Press  to select it. Then navigate to **Back** to return to live view.

Instead of the arrow buttons, you can also use the joystick on the keypad.

## TVR 41 mapping to the KTD-405 keypad

Table 22: TVR 41 mapping to the KTD-405 keypad

Task	Keypad action	Further information
<b>• Menu mode</b>		
Call up or exit menu	In live view, press <b>esc</b> .	To logout of the menu: go to the Power Manager menu and select Logout.
Move through the menus	Press and hold <b>esc</b> and then press the arrow buttons or use the joystick.	 <b>Down</b> ,  <b>Up</b> ,  <b>Left</b> ,  <b>Right</b>
Move between menu tabs	Press Zoom + or Zoom - to switch between menu tabs.	
Navigate to a menu option	Press and hold <b>esc</b> and then press the arrow buttons.	 <b>Down</b> ,  <b>Up</b> ,  <b>Left</b> ,  <b>Right</b>
Select a character or menu option	Press <b>Enter</b> (  ).	<b>Note.</b> If you press <b>esc</b> before pressing <b>Enter</b> , you quit the menu without saving any changes. It is the same as cancel.
Select the zone ID	Press <b>zone</b> to connect the keypad to the DVR.	
<b>• Live view mode</b>		
Call up a single camera	Press <b>0</b> to <b>9</b> and then press <b>Enter</b> (  ).	Using the numeric buttons <b>0</b> to <b>9</b> , enter the number of the camera and then press <b>Enter</b> (  ).
Call up multiview screens	Press <b>view</b> and then continue to press button <b>5</b> to scroll through the options available.	
Sequence through cameras	Press the <b>seq</b> button to scroll through the cameras in full screen.	
Switch to next/previous camera	Move the joystick to the right (= next camera), or the left (= previous camera)	

Task	Keypad action	Further information
Switch between monitor A and monitor B	Press the <b>mon</b> button and button <b>1</b> to switch to monitor A. Press the <b>mon</b> button and button <b>2</b> to switch to monitor B.	
Manually acknowledge an alarm	Press <b>Alarm</b> .	
<b>• PTZ functions</b>		
Enter PTZ mode	In live view mode, press <b>Enter</b> (↵).	It is possible that you first need to login before you can access the PTZ mode.
PTZ functions (Up, Down, Left, Right, Zoom in, Zoom out)	Move the joystick to move the dome up, down, left and right  Press <b>zoom+</b> and <b>zoom-</b> .	<b>KTD-405U:</b> Turn the knob on the joystick to zoom in/zoom out. <b>KTD-405-2DU:</b> Press the <b>zoom+</b> and <b>zoom-</b> buttons.
Leave PTZ mode	Press <b>esc</b> .	
<b>• Playback functions</b>		
Search for recorded video	Press  .	Once password is entered, the <b>Advanced Search</b> menu appears.
Instant playback	Press  when in full screen.	Instant playback of the currently selected camera. Default time is 5 minutes. Other cameras listed on-screen can only be accessed using the mouse.
Stop playback	Press  to stop playback and return to live view mode.	
Pause playback	Press  to pause playback. Press  to restart.	
Replay the current file.	Press <b>aux4</b> to replay the current file.	<del>Starts at the beginning of the file.</del>
Change playback speed	Press and hold <b>esc</b> and then press the left/right arrow buttons or move the joystick to the left/right.	
Jump 30 seconds forwards or backwards during playback	Press and hold <b>esc</b> and then press the up/down arrow buttons or move the joystick to the left/right.	

## Selecting a camera using the keypad

The TVR 41 can support up to 16 analog cameras. To be able to control up to 16 cameras using the keypad, you may need to change the number of TVR 41 camera inputs controlled by the keypad. The default number of TVR 41 camera inputs controlled by the keypad is 16.

### To change the number of TVR 41 camera inputs controlled by the keypad:

1. Hold down the Enter button (↵) until a beep sounds and then enter the following code: **1 4 7 6**. Push the **seq** button to confirm.
2. Scroll through the menus with the **▶▶** button until this menu appears:

```
ENTER ZONE ADDRESS: 01
(01-32)                ◀◀NEXT▶▶
```

3. Enter the DVR address to be configured and press ↵.
4. Scroll through the menus with the **▶▶** button until this menu appears:

```
ZONE 01 HUB:           DVMRE DUP
(↑,↓)=SELECT          ◀◀NEXT▶▶
```

5. Press the up/down arrow buttons to navigate to SYM DVR.
6. Scroll through the menus with the **▶▶** button until this menu appears:

```
ZONE 01 CAM. INPUTS   16
(↑,↓)=SELECT          ◀◀NEXT▶▶
```

7. Press the up/down arrow buttons to navigate to 32.
8. Repeat steps 3 to 7 for each DVR address in the keypad.

## Controlling a camera

When setting up and controlling your cameras in zone mode, refer to Table 23 below for the list of default PTZ addresses associated with a zone ID. This value is automatically populated in the system. You can modify the PTZ address in the PTZ menu to meet customer requirements (see “Configuring PTZ settings” on page 43).

**Table 23: Default PTZ camera addresses by zone ID**

Camera input	Zone ID of TVR 41															
	1	2	3	4	5	6	7	8	9	10	11	12	13	14	15	16
1	0	32	64	96	128	160	192	224	256	288	320	352	384	416	448	480
2	1	33	65	97	129	161	193	225	257	289	321	353	385	417	449	481
3	2	34	66	98	130	162	194	226	258	290	322	354	386	418	450	482
4	3	35	67	99	131	163	195	227	259	291	323	355	387	419	451	483

Camera input	Zone ID of TVR 41															
	1	2	3	4	5	6	7	8	9	10	11	12	13	14	15	16
5	4	36	68	100	132	164	196	228	260	292	324	356	388	420	452	484
6	5	37	69	101	133	165	197	229	261	293	325	357	389	421	453	485
7	6	38	70	102	134	166	198	230	262	294	326	358	390	422	454	486
8	7	39	71	103	135	167	199	231	263	295	327	359	391	423	455	487
9	8	40	72	104	136	168	200	232	264	296	328	360	392	424	456	488
10	9	41	73	105	137	169	201	233	265	297	329	361	393	425	457	489
11	10	42	74	106	138	170	202	234	266	298	330	362	394	426	458	490
12	11	43	75	107	139	171	203	235	267	299	331	363	395	427	459	491
13	12	44	76	108	140	172	204	236	268	300	332	364	396	428	460	492
14	13	45	77	109	141	173	205	237	269	301	333	365	397	429	461	493
15	14	46	78	110	142	174	206	238	270	302	334	366	398	430	462	494
16	15	447	79	111	143	175	207	239	271	303	335	367	399	431	463	495
17	16	48	80	112	144	176	208	240	272	304	336	368	400	432	464	496
18	17	49	81	113	145	177	209	241	273	305	337	369	401	433	465	497
19	18	50	82	114	146	178	210	242	274	306	338	370	402	434	466	498
20	19	51	83	115	147	179	211	243	275	307	339	371	403	435	467	499
21	20	52	84	116	148	180	212	244	276	308	340	372	404	436	468	500
22	21	53	85	117	149	181	213	245	277	309	341	373	405	437	469	501
23	22	54	86	118	150	182	214	246	278	310	342	374	406	438	470	502
24	23	55	87	119	151	183	215	247	279	311	343	375	407	439	471	503
25	24	56	88	120	152	184	216	248	280	312	344	376	408	440	472	504
26	25	57	89	121	153	185	217	249	281	313	345	377	409	441	473	505
27	26	58	90	122	154	186	218	250	282	314	346	378	410	442	474	506
28	27	59	91	123	155	187	219	251	283	315	347	379	411	443	475	507
29	28	60	92	124	156	188	220	252	284	316	348	380	412	444	476	508
30	29	61	93	125	157	189	221	253	285	317	349	381	413	445	477	509
31	30	62	94	126	158	190	222	254	286	318	350	382	414	446	478	510
32	31	63	95	127	159	191	223	255	287	319	351	383	415	447	479	511



# Appendix E

## Maximum pre-recording times

The maximum pre-recording time that can be selected depends on the bit rate. Frame rate, resolution and image quality do not impact time.

**Note:** This information only applies when the bit rate is set to Constant (see “Initializing recording settings” on page 87 for more information).

Constant bit rate	Maximum pre-recording time (seconds)
32	30
48	30
64	30
80	30
96	30
128	30
160	30
192	30
224	30
256	30
320	30
384	30
448	30
512	30
640	30
768	30
896	30
1024	30
1280	25
1536	20

<b>Constant bit rate</b>	<b>Maximum pre-recording time (seconds)</b>
1792	15
2048	15
3072	10
4096	5

# Appendix F

## Supported PTZ commands

**Table 24: Supported PTZ commands by camera protocols (Part 1)**

Protocol	PTZ command												
	Tilt up	Tilt down	Pan left	Pan right	Left up	Left down	Right up	Right down	Auto pan	Zoom +	Zoom -	Focus +	Focus -
Interlogix-485	Y	Y	Y	Y	N	N	N	N	N	Y	Y	Y	Y
Interlogix-422	Y	Y	Y	Y	N	N	N	N	N	Y	Y	Y	Y
KALATEL	Y	Y	Y	Y	N	N	N	N	N	Y	Y	Y	Y
DSCP	Y	Y	Y	Y	N	N	N	N	N	Y	Y	Y	Y
HIKVISION	Y	Y	Y	Y	Y	Y	Y	Y	Y	Y	Y	Y	Y
Honeywell	Y	Y	Y	Y	N	N	N	N	N	Y	Y	Y	Y
INFINOVA	Y	Y	Y	Y	N	N	N	N	N	Y	Y	Y	Y
KTD-348	Y	Y	Y	Y	N	N	N	N	N	Y	Y	Y	Y
LG MULTIX	Y	Y	Y	Y	N	N	N	N	N	Y	Y	Y	Y
LILIN	Y	Y	Y	Y	N	N	N	N	N	Y	Y	Y	Y
PANASONIC_CS850	Y	Y	Y	Y	N	N	N	N	N	Y	Y	Y	Y
PELCO-D	Y	Y	Y	Y	Y*	Y*	Y*	Y*	Y	Y	Y	Y	Y
PELCO-P	Y	Y	Y	Y	Y*	Y*	Y*	Y*	Y	Y	Y	Y	Y
PHILIPS	Y	Y	Y	Y	N	N	N	N	N	Y	Y	Y	Y
PHILIPS-3	Y	Y	Y	Y	N	N	N	N	N	Y	Y	Y	Y
SAE	Y	Y	Y	Y	N	N	N	N	N	Y	Y	Y	Y
Samsung	Y	Y	Y	Y	N	N	N	N	N	Y	Y	Y	Y
Siemens	Y	Y	Y	Y	N	N	N	N	N	Y	Y	Y	Y
SONY-EVI-D30/31	Y	Y	Y	Y	N	N	N	N	N	N	N	N	N
SONY-EVI-D70	Y	Y	Y	Y	N	N	N	N	N	N	N	N	N
SONY-EVI-D100/P	Y	Y	Y	Y	N	N	N	N	N	N	N	N	N
TECHWIN	Y	Y	Y	Y	N	N	N	N	N	N	N	N	N
VICON	Y	Y	Y	Y	N	N	N	N	N	Y	Y	Y	Y

Protocol	PTZ command												
	Tilt up	Tilt down	Pan left	Pan right	Left up	Left down	Right up	Right down	Auto pan	Zoom +	Zoom -	Focus +	Focus -
YOULI	Y	Y	Y	Y	N	N	N	N	N	Y	Y	Y	Y

\*: Hikvision only.

**Table 25: Supported PTZ commands by camera protocols (Part 2)**

Protocol	PTZ command										
	Iris+	Iris-	Light	Wiper	Zoom area	Center	Menu	Preset	Tour	Shadow tour	
Interlogix-485	Y	Y	N	N	N	N	N	Y	N	Y	
Interlogix-422	Y	Y	N	N	N	N	N	Y	N	Y	
KALATEL	Y	Y	N	N	N	N	N	Y	N	Y	
DSCP	Y	Y	N	N	N	N	N	Y	N	Y	
HIKVISION	Y	Y	N	N	Y	Y	Y	Y	Y	Y	
Honeywell	Y	Y	N	N	N	N	N	N	N	N	
INFINOVA	Y	Y	N	N	N	N	N	Y	N	Y	
KTD-348	Y	Y	N	N	N	N	N	Y	N	Y	
LG MULTIX	Y	Y	N	N	N	N	N	Y	Y	Y	
LILIN	Y	Y	N	N	N	N	N	N	N	N	
PANASONIC_CS850	Y	Y	N	N	N	N	N	Y	N	Y	
PELCO-D	Y	Y	Y**	Y#	N	N	N	Y	Y	Y	
PELCO-P	Y	Y	N	N	N	N	N	Y	Y	Y	
PHILIPS	Y	Y	N	N	N	N	N	N	N	N	
PHILPS-3	Y	Y	N	N	N	N	N	N	N	N	
SAE	Y	Y	N	N	N	N	N	Y	Y	Y	
Samsung	Y	Y	N	N	N	N	N	Y	N	Y	
Siemens	Y	Y	N	N	N	N	N	Y	N	Y	
SONY-EVI-D30/31	N	N	N	N	N	N	N	N	N	N	
SONY-EVI-D70	N	N	N	N	N	N	N	N	N	N	
SONY-EVI-D100/P	N	N	N	N	N	N	N	N	N	N	
TECHWIN	Y	Y	N	N	N	N	N	Y	N	N	
VICON	Y	Y	N	N	N	N	N	N	N	N	
YOULI	Y	Y	N	N	N	N	N	Y	N	N	

\*\* : Aux. 2

# : Aux. 1

# Appendix G

## Default menu settings

<b>Display mode setting</b>	
Monitor	
General	
	Language: English
	Device name: TVR 41
	Device address: 255
	Zone ID: 1
	VGA resolution: 1280*1024/60HZ
	HDMI resolution : 1920*1080/60HZ(1080P)
	Password required : Yes
	Scale output video: Yes
	Enable wizard: Yes
More settings	
	Monitor standard: NTSC/PAL. Auto detect at booting.
	Output mode: Standard
	Monitor brightness: 5
	Event hint: Yes
	Time bar transparent: Yes
	Enable timebar: Yes
	Menu timeout: 5 min
	Mouse pointer speed: Lower
Layout	
General	
	Video output interface: VGA
	Live view mode: 3*3
	Dwell time: No switch
	Enable audio output: No
	Event output: HDMI

		Event full screen monitoring dwell time: 10 s
		Alarm full screen monitoring dwell time: 10 s
	<b>View</b>	
		Video output interface: VGA
		16 chan: 4*4 -A1 to A16
		8 chan: 3*3 - A1 to A8+1black screen
		4 chan: 2*2 - A1 to A4 (Different with PRD-5.1-138)
	<b>Time</b>	
	<b>Time settings</b>	
		Time Zone: GMT -8
		Date Format: MM-DD-YYYY
		Time format: 24 hr
		Display week: No
		System date: Current system date
		System time: Current system time
		Auto DST Adjustment: No
		Enable DST: No
		From: Apr 1st Sun 2:00
		To: Oct last Sun 2:00
		DST bias: 60 min
	<b>Holiday</b>	
	<b>Holiday settings</b>	
		Status: All disable; Start date: 1st. Jan; End date: 1st Jan
<b>Camera Management</b>		
	<b>OSD</b>	
	<b>OSD settings</b>	
		Camera: Analog 1
		Camera name: Camera 01
		Display name: Yes
		Display date: Yes
		Display week: Yes
		Date format: MM-DD-YYYY
		Time format: 12-hour
		Display mode: Not transparent & not flashing

Image	
	Image settings
	Camera: Analog 1
	Mode: Standard
Motion	
	Motion detection settings
	Camera: Analog 1
	Enable motion detection: No
	Rule: Trigger channel [Camera 1]; Arming schedule: All day for whole week; Rule: (Null)
	Sensitivity: Middle
	Target size: 1
	Zone: Full screen
Privacy mask	
	Privacy mask settings
	Camera: Analog 1
	Enable privacy mask: No
	Zone: (Null)
Tamper-proof	
	Tamper-proof settings
	Camera: Analog 1
	Enable tamper proof: No
	Rule: Alarm schedule all day for whole week; Rule: (Null)
	Sensitivity: Low
	Zone: (Null)
Video loss	
	Video loss settings
	Camera: Analog 1
	Enable video loss Alarm: Disable
	Rule: Alarm schedule all day for whole week; Rule: (Null)
Covert camera	
	Covert camera settings
	Camera: (Null)

<b>Video Schedule</b>	
Schedule	
Record	
	Camera: Analog 1
	Enable Schedule: Yes
	Schedule: All day for whole week TL-Hi
Encoding parameters	
Record	
	Camera: Analog 1
	Encoding parameters: Mainstream (TL-Hi)
	Stream type: Video-Audio
	Resolution: 2CIF
	Bit rate type: Variable
	Video quality: Medium
	Frame rate: 4 fps
	Max. bit rate mode: General
	Max. bit rate: 1792
	Pre-record: 5 s
	Post-record: 5 s
	Auto delete: 0
	Record audio: Yes
Capture	
	Camera: Analog 1
	Resolution: 4 CIF
	Picture quality: Medium
V-stream encoding	
	Enable V-stream encoding: No
	Frame rate : 25 fps
	Max. bit rate: 1792
Encode parameters suggestion	
	Duration time (days): 30
	Weekday: Yes
	Weekend: Yes
	Resolution: 2CIF
	Calculate: (Null)



Auto archive	
Archive settings	
Enable auto archive: No	
Start time:	
End time:	
Interval time: 1 hr	
Dev full handle: Stop archiving	
Device select: SATA1 CD/DVD-RW	
Archive status	
(Null)	
Manual record	
Cameras: All off	
More settings	
More settings	
Event priority: Text In < Motion	
Overwrite: Yes	
eSATA: Record/Capture	
Network settings	
General	
General	
NIC Type: 10/100/1000M self-adaptive	
Enable DHCP: Enable	
IPv4 address: 192.168.1.82	
IPv4 subnet mask: 255.255.255.0	
IPv4 default gateway: 192.168.1.1	
IPv6 address1: fe80::240:3dff:fe7e:926f/64	
IPv6 address2: (Null)	
IPv6 address gateday: (Null)	
Mac address: (It depends)	
MTU: 1500	
Preferred DNS server: (Null)	
Alternate DNS server: (Null)	
PPPoE	
PPPoE	
Enable PPPoE: Disable	
User name: (Null)	
Password: (Null)	
Confirm: (Null)	

DDNS	
DDNS	DDNS: No
	DDNS type: ezDDNS
	Server address: www.tvr-ddns.net
	Host Name: (Null)
NTP	
NTP	Enable NTP: No
	Interval: 60min
	NTP server: time.nist.gov
	NTP Port:123
Email	
Email	Email server authentication: No
	User name: (Null)
	Password: (Null)
	SMTP server: (Null)
	SMTP port: 25
	Enable SSL: No
	Seder: (Null)
	Sender's address: (Null)
	Select receivers: Receiver 1
	Receiver: (Null)
	Receiver's address: (Null)
	Enable attached picture: No
	Interval: 2s
FTP	
FTP	Enable FTP: No
	FTP server: (Null)
	FTP port: (Null)
	User name: (Null)
	Password: (Null)
	Directory: Use root directory
	Parent directory: (Null)
	Secondary directory: (Null)

SNMP	
SNMP	
	Enable SNMP: No
	SNMP version: V2
	SNMP port: 161
	Read community: Public
	Write community: Private
	Trap address: (Null)
	Trap port: 162
UPnP	
UPnP	
	Enable UpnP: No
	Mapped type: Auto
More settings	
More settings	
	Alarm host IP: (Null)
	Alarm host port: 0
	Server port: 8000
	HTTP port: 80
	Multicast IP: (Null)
	RTSP server port: 554
Alarm settings	
Alarm list	
Alarm Inputs	
	No.: (Null)
	Alarm name: (Null)
	Alarm type: NO
Alarm Outputs	
	No.: (Null)
	Alarm name: (Null)
	Time out: 5 s
Alarm Input	
Alarm Input	
	Alarm input no.: A<1
	Alarm name: (Null)
	Type: NO
	Enable alarm input: No
	Rule: Trigger channel (None); Arming schedule (All)

	day for whole week); Rule (Null); PTZ linking: (Null)
Alarm Output	
	Alarm Output
	Alarm output no.: A>1
	Alarm name: (Null)
	Time out: 5 s
	Rule: All day for whole week
	Manual Alarm
	Trigger none
Alarm audio	
	(Null)
Notification	
	Notification
	Notification type: HDD full
	Audible warning: No
	Notify surveillance center: No
	Send email: No
	Trigger alarm output: No
Advanced settings	
	Advanced settings
	System buzzer time: Constant
	Camera buzzer time: Constant
PTZ setting	
	General
	General
	Camera: Analog 1
	Baud rate: 9600
	Data bit: 8
	Stop bit: 1
	Parity: None
	Flow ctrl: None
	PTZ protocol: Interlogix 485
	Address: 0
	More settings
	(Null)
User management	
	User
	User management

	admin: (Null)
	operate: (Null)
	guest: (Null)
	Change password
	(Null)
System settings	
	RS-232
	RS-232 setting
	Baud rate: 115200
	Data bit: 8
	Stop bit: 1
	Parity: None
	Flow ctrl: None
	Usage: ProBridge
	Hard disk
	(Null)
	Text insertion
	Text intertion
	Enable text intertion: No
	Access device: (Null)
	Access mode: (Null)
	Start setting: (Null)
	Upgrade
	Locall upgrade
	Device name: SATA1 CD/DVD-R/W
	FTP: (Null)
	Configuration
	Import/export config file
	Device name: SATA1 CD/DVD-R/W
	Default : (Null)
	Log search
	Log search
	Current whole day, all day, all type
	System information
	Device information
	Device name: TVR41
	Model: [model number]
	Serial no.: [serial number]

	Firmware version: [firmware version number]
	Encoding version: [encoding version number]
	Panel version: [panel version number]
	Net detect: (Null)
Net detect	
	Traffic
	Network detection
	Select NIC: LAN1
	Destination address: (Null)
	Device name: SATA1 CD/DVD-R/W
	Network stat.
	Remote live view: 0 bps
	Remote playback: 0 bps
	Net total idle: 80 Mbps
	Net total limit: 80 Mbps

---

# Index

## A

- Active X, 71
- Alarm audio messages, 98
- Alarm notifications
  - alarm audio messages, 98
  - external alarms, 102
  - modifying the warning buzzer, 100
  - types, 97
  - video loss, 105
  - video tampering, 106
- Alarm outputs
  - manually acknowledging, 104
- Alarm/event sequencing, 37
- Archiving
  - manually exporting files to a backup device, 66
  - quick archive, 65
  - schedule automatic archiving, 68
  - snapshots, 69
  - video clips, 69
- Audio
  - connecting audio inputs and outputs, 13
- Audio enable/disable
  - quick access, 34
- Automatically archiving files, 68

## B

- Back panel description, 4
- Backup devices
  - managing, 70
- Bandwidth throttle
  - configuring, 118
- Bookmarks
  - playback, 59
  - saving, 59
  - types, 59
- Brightness, contrast and saturation
  - modifying, 131

## C

- Cameras
  - configuring PTZ dome cameras, 43
  - connecting analog cameras using loop-through, 13

- privacy masking, 130
- setting up alarm/event sequencing, 37
- setting up sequencing, 37
- Covert cameras, 131

## D

- Daily schedules
  - recording, 91
- Date
  - configuring display, 38
- DDNS settings, 111
- Default menu settings, 167
- Digital zoom
  - description, 35
  - quick access, 34
  - quick access, 54
- Digital zoom in playback, 63
- Disk analysis
  - searching recorded video, 126
- DST
  - set up, 38
- Dual streaming
  - browser, 80
  - recording, 123
- Dwell time, 35
  - alarms and events, 35

## E

- E-mail notifications
  - set up, 112
- eSATA, 125
- Event logs
  - searching remotely, 79
- Export configuration settings, 138
- Export files, 70
- External alarm
  - setting up to record when triggered, 102
- External alarm schedules
  - recording, 93

## F

- Factory default settings
  - restore, 135
- Firmware
  - updating, 134

Frame-by-frame playback, 62  
 Front panel description, 20  
 FTP server settings, 115  
 Full screen viewing, 32

## H

### HDD

- checking status, 124
- grouping, 122
- initializing, 121
- properties, 123
- quota, 121
- redundancy, 95
- set to read only, 95
- setting up HDD alarms, 124

Holiday schedules

- recording, 92

HTTP port settings, 116

## I

Image settings

- quick access, 34

Import configuration settings, 138

Instant playback, 54

- change default time, 54

- quick access, 34

IP devices supported, 150

iTVRmobile

- device management, 146
- favorites, 147
- live view, 144
- login, 143
- PTZ camera control, 145

## K

Keypad

- connecting dome cameras to the DVR, 6
- connecting to RS-485 port, 12
- wiring to DVR, 10

KTD-405

- changing the camera inputs controlled by the keypad, 161

KTD-405 keypad

- accessing DVR functions, 158
- controlling a camera, 161
- firmware supported, 155
- set up in zone mode, 156
- set up TVR 41 device address, 156
- wiring, 155

## L

Live view mode

- digital zoom, 35
- full screen view, 32
- multiview, 32
- sequencing cameras, 33

- time and date display, 38

Lock/unlock recorded files, 94

Logs

- view system log, 137

## M

Main menu

- accessing, 25
- description, 25
- icon descriptions, 25

Manual recording, 93

- quick access, 34

Manually archiving files, 66

Monitors

- audio output, 29
- connecting, 13
- priority level, 29
- select main and spot monitors, 35
- video output, 29

Motion detection, 100

- defining motion detection area, 100
- setting the sensitivity level, 100
- setting the target size, 100

Motion search

- playback, 62

Motion search toolbar

- quick access, 54

Mouse pop-up menu, 30

Multicast settings, 116

Multiview, 32

## N

NAS, 84

Network packet data

- exporting, 118

Network settings

- general set up, 109

Network status, 117

Network storage system

- set up, 84

Network traffic

- checking, 117

Notifications

- external alarms, 102
- system event types, 105

NTP server, 112

## O

OSD settings, 129

Overwriting

- Protecting recorded files, 94

## P

Password

- changing user password, 142
- default user passwords, 139



- Playback
  - bookmarks, 59
  - changing playback speed, 62
  - instant playback, 54
  - interface overview, 51
  - motion search, 62
  - playing back archived files, 70
  - pop-up menu description, 54
  - search by event, 58
  - search by time, 57
  - search by video type, 57
  - search results, 56
  - set up for text insertion, 58
  - skip time, 61
  - snapshots, 60
  - system log, 60
  - using digital zoom, 63
  - using the web browser, 77
- Playback control toolbar
  - description, 52
  - quick access, 54
- Player
  - using for playback, 70
- Port forwarding, 72, 153
- Power up and down DVR, 15
- PPPoE settings, 110
- Pre-recording times
  - maximum times, 163
- Preset tours
  - calling up, 47
  - quick access, 44
  - setting up, 47
- Presets
  - calling up, 46
  - quick access, 44
  - selecting, setting up and deleting, 45
- Privacy masking, 130
- Protecting recorded files, 94
- PTZ control panel
  - description, 44
  - quick access, 34
- PTZ dome cameras
  - assigning protocols, 43
  - configuring, 43
  - connecting dome cameras to the DVR, 6
  - connecting to RS-485 port, 12
  - controlling remotely, 81
  - set up, 5
- PTZ protocols, 151
  - assigning, 43
  - configuring Interlogix cameras, 6
  - PTZ commands supported, 165
- R**
- Recorded files
  - lock/unlock, 94
  - Protect HDD, 95
- Recording
  - configuring settings, 87
  - protecting against overwriting, 94
  - recording schedules, 90
  - setting up HDD redundancy, 95
- Recording schedules
  - daily, 91, 92
  - defining, 90
  - external alarms, 93
- Remote alarm host settings, 115
- Remote control
  - connect to the DVR, 24
  - description, 22
- RS-232 port
  - configuring, 133
- RTSP service port, 116
- S**
- S.M.A.R.T. information on a HDD, 125
- SAN, 84
- Sequencing cameras, 33, 37
  - dwelt time, 35
- Setup wizard
  - using, 16
- Shadow tours
  - quick access, 44
  - setting up, 48
- Skip time
  - playback, 61
  - quick access, 54
- Snapshots
  - archiving, 69
  - capture remotely, 77
  - capturing, 34
  - playback, 60
  - upload to FTP server, 115
- SNMP protocol settings, 115
- Soft keyboard, 26
- System information
  - view, 136
- System logs
  - playback, 60
  - view, 137
- System notifications
  - event types, 105
- T**
- Text insertion
  - quick access to display, 54
  - search recorded video, 81
  - set up, 81
- Text overlay
  - browser, 83
- Time
  - configuring display, 38
- U**
- User privileges

- camera configuration, 141
  - descriptions, 140
  - local configuration, 140
  - remote configuration, 141
- Users
- adding a new user, 139
  - customizing user privileges, 140
  - deleting a user, 141
  - managing, 139
  - modifying user information, 142
  - user levels, 139

## V

- Video format
  - PAL/NTSC, 15
- Video loss
  - setting up detection, 105
- Video tampering
  - setting up to detect, 106
- View system log, 137

- V-stream encoding, 42

## W

- Warning buzzer
  - modifying, 100
- Web browser
  - accessing, 72
  - dual streaming, 80
  - installing Active X, 71
  - local configuration of DVR, 74
  - ports, 72
  - remote configuration of DVR, 75
  - searching and playing back recorded video, 77
  - searching for event logs, 79
  - text insertion, 81
  - text overlay, 83
  - video snapshot, 77