

# Backup Camera System with Flush Mount Camera (FMVSS 111 Compliant)

## Product Manual



## What's in the Box?



- 1 x 7" LED Digital Color Monitor
- 1 x Flush Mount Backup Camera
- 1 x 66' Camera Cable
- 1 x Universal Swivel Head Mount
- 1 x Power Harness
- 1 x Remote Control
- 1 x Hole Saw
- 1 x Screw Kit For Installation

# Table of Contents

|                                    |       |
|------------------------------------|-------|
| Introduction.....                  | 4     |
| Safety Information .....           | 5-7   |
| Before Beginning Installation..... | 8     |
| Installation Guide.....            | 9     |
| Wiring Camera & Monitor.....       | 10-11 |
| Installation Diagram .....         | 12    |
| Installing the Monitor .....       | 13    |
| Monitor Operation.....             | 14    |
| Splitting & Splicing .....         | 15    |
| FMVSS 111.....                     | 16    |
| Monitor Dimensions.....            | 17    |
| Monitor Specifications.....        | 18    |
| Camera Dimensions.....             | 19    |
| Camera Specifications.....         | 20    |
| Troubleshooting.....               | 21    |
| Warranty.....                      | 22    |
| Disclaimer .....                   | 23    |

# Introduction

Please read all of the installation instructions carefully before installing the product. Improper installation will void manufacturer's warranty.

Congratulations on purchasing a Rear View Backup Camera System! With this manual you will be able to properly install and operate the unit.

The Backup Camera System is intended to be installed as a supplement aid to your standard rear view mirror that already exists in your vehicle. The Backup Camera System should not be used as a substitute for the standard rear view mirror or for any other mirror that exists in your vehicle.

In some jurisdictions, it is unlawful for a person to drive a motor vehicle equipped with a TV viewer or screen located forward of the back of the driver's seat or in any location that is visible, directly or indirectly, to the driver while operating the vehicle.

# Safety Information

Please read the entire manual and follow the instructions and warnings carefully. Failure to do so can cause serious damage and/or injury, including loss of life. Be sure to obey all applicable local traffic and motor vehicle regulations as it pertains to this product. Improper installation will void manufacturer's warranty.

## USAGE

- The Rear View Camera System is designed to help the driver safely detect people and/or objects helping to avoid damage or injury. However, you the driver, must use it properly. Use of this system is not a substitute for safe, proper or legal driving.
- Never back up while looking at the monitor alone. You should always check behind and around the vehicle when backing up, in the same way as you would if the vehicle did not have the Rear View Camera System. If you back up while looking only at the monitor, you may cause damage or injury. Always back up slowly.
- The Rear View Camera System is not intended for use during extensive back-up maneuvers or backing into cross traffic or pedestrian walkways.
- Please, always remember, the area displayed by the Rear View Camera System is limited. It does not display the entire panorama that is behind you.

# Safety Information

## INSTALLATION

- Electric shock or product malfunction may occur if this product is installed incorrectly.
- Use this product within the voltage range specified. Failure to do so can cause electronic shock or product malfunction.
- Take special care when cleaning the monitor.
- Make sure to firmly affix the product before use.
- If smoke or a burning smell is detected, disconnect the system immediately.
- Where the power cable may touch a metal case, cover the cable with a friction tape. A short circuit or disconnected wire may cause a fire.
- While installing the Rear View System be careful with the wire positioning in order to avoid wire damage.
- The Rear View System should only be used when the vehicle is in reverse.
- Do not watch movies or operate the monitor while driving; as it may cause an accident.
- Do not install the monitor where it may obstruct drivers view or obstruct an air bag device.
- Dropping the unit may cause possible mechanical failure.

## Safety Information

If you have questions about this product, contact:

Customer Service:  
Rear View Safety  
1797 Atlantic Avenue  
Brooklyn, NY 11233  
Tel: 800.764.1028

IN NO EVENT SHALL SELLER OR MANUFACTURER BE  
LIABLE FOR ANY DIRECT OR CONSEQUENTIAL DAMAGES OF  
ANY NATURE, OR LOSSES OR EXPENSES RESULTING FROM  
ANY DEFECTIVE PRODUCT OR THE USE OF ANY PRODUCT.



A Safe Fleet Brand

## Before Beginning Installation

Before drilling please check that no cable or wiring is on the other side of the wall. Please clamp all wires securely to reduce the possibility of them being damaged while vehicle is in use. Keep all cables away from hot or moving parts and electrical noisy components.

We recommend doing a benchmark test before installation to insure that all components are working properly.

Step 1: Choose the monitor and camera locations.

Step 2: Install all cables in vehicle, when necessary a 0.8 (20mm) hole should be drilled for passing camera cable through vehicles walls. Install split grommets where applicable.

Step 3: Once all cables and wiring have been properly routed, perform a system function test by temporarily connecting the system. If the system seems to not be operating properly see troubleshooting (page 22).



## Cable

1. Be sure to position the cable properly. The camera cable uses aircraft grade connectors which means the camera cable can be exposed to all weather elements. Do not run the cable over sharp edges, do not kink the cable and keep away from HOT and rotating parts.
2. Fasten all cables and secure all excess cable.

## Monitor

1. To Attach the Pedestal mount to the dashboard or to the headliner use self-tapping screws and/or the adhesive pad.
2. Attach monitor to mount, and adjust mounting angle to allow optimum driver viewing comfort. (see figure 1.1 on page 12)

# Installation Guide

## The Power Harness.

- To power the system connect the power (RED) 12V+ wire to ignition power and the ground (BLACK) wire to chassis ground.
- These are the only wires needed to power the entire system and all the cameras. Each camera can be seen at any time by simply pressing the power button and using the V1/2 button to toggle.
- The three positive trigger wires (WHITE-CH1, BROWNCH2, BLUE-CH3) each represent one channel and will turn on their channel when the trigger wire is energized with 12V.
- "Camera 3" is the designated backup channel. To have the the backup camera come on when you go into reverse, connect the BLUE wire to reverse power (or any power source that comes on only in reverse).
- The other channels can simi-

larly be triggered (i.e. side cameras can be triggered by the turn signals etc.)

- To automatically have camera and monitor turn ON when vehicle activates, simply twist BLUE positive trigger 12V+ to Red Power line 12V+ and wire to ignition power.

Note: This setup will disable the menu in channel 3. To access the menu simply move to channel 1 or 2 and all the changes will apply to channel 3.

Note: When the blue wire is active it will have precedence over the other triggers. Therefore, if you wish to use multiple triggers, do not attach the blue trigger to constant power.

## Wiring Camera & Monitor

- **Audio:** There is audio on channels 2 and 3. On channel 3 the blue trigger wire must be energized (12V) to activate the audio. On channel 2 the audio is always on.
- **Grid-lines:** The grid-lines are also carried through the blue wire. To use the grid-lines for reversing, connect the blue wire to a reverse power.
- There is a built-in voltage regulator for our systems which can handle 12-24 volts. Real consumption is 10 to 30 Volts.

**Note:** The camera and monitor can always be activated by manually pushing the power button on monitor. This is in addition to utilizing the positive triggers.

**Note:** If connecting power directly to battery, the camera is always ON and therefore can drain battery. Therefore it is recommended to connect power to an ignition switched accessory power source.

# Installation Diagram

Figure 1.1

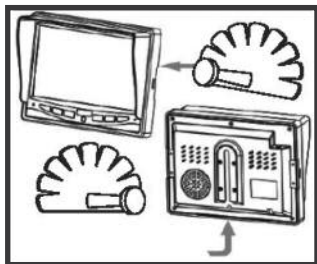

Figure 1.2

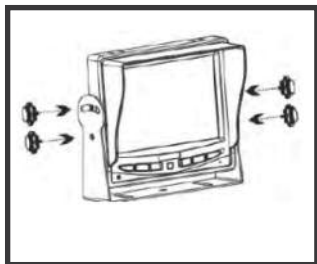

Figure 1.3

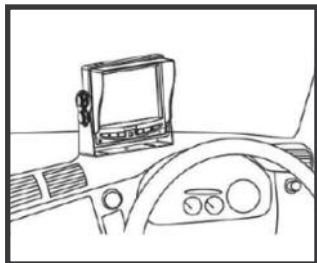
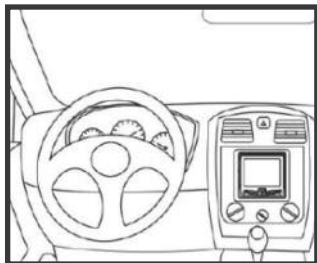

Figure 1.4



**Connection of U  
Bracket**

**Connection of  
Flushmount Bracket**

# Installing the Monitor

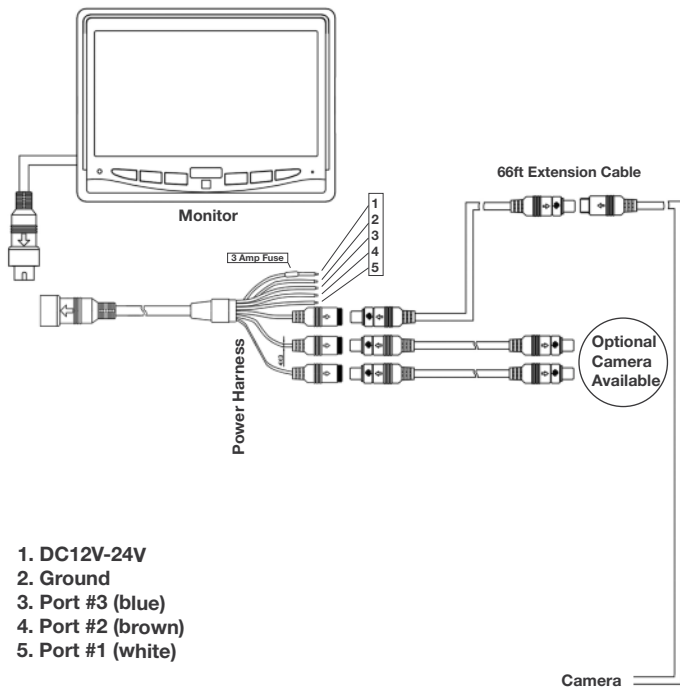

# Monitor Operation

CAMERA  
SELECTION

DOWN  
ARROW

MENU/  
SELECTION  
BUTTON

UP  
ARROW

POWER  
ON/OFF

ROTATE  
IMAGE  
(Back/Exit  
when in  
Menu Mode)

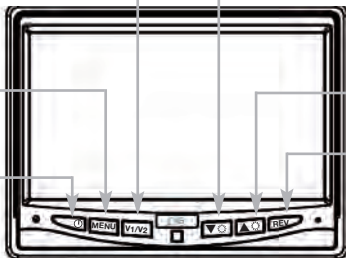

- "Brightness" "Contrast" "Saturation" "Sharpness": adjust image properties
- Picture Adjust: Stretch image horizontally (right/left and left/right)
- Turn: Toggle between mirror/normal image on each individual channel
- Day/Night: Toggle between back-lit buttons and auto dimming
- Name: Change name of each individual channel
- Trigger Source: Toggle channel destination for each trigger
- Trigger Delay: Adjust time delay on each trigger
- Distance Grid: Toggle which channel distance grid lines will display on
- Grid Position: Adjust grid lines
- Auto Power: On: Monitor will automatically turn on when powered. Off: Monitor will only turn on when triggered. Auto: Monitor will follow previous state.
- Reset: Reset settings to factory default

# Splitting & Splicing

Installing sun shield: Put shade cover on the display. Installing back cover: Put the monitor with shade cover in the back cover (only for embedded monitor)



Splitting back cover: Hold monitor with 2 hands and detach with fingers, as indicated by arrows. (only for embedded monitor)



Splitting sun shield: Take the monitor with the left hand and detach with right hand as indicated by the white arrow. (see below)

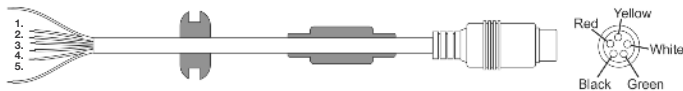

- 1. Red - Power (+)**
- 2. Yellow - Video**
- 3. Green - Mirror / Normal Imaging**
- 4. White - Audio**
- 5. Black - Ground (-)**

# FMVSS 111



All new vehicles with a gross weight (GVWR) of 10,000 pounds or less, will have to have a rear view camera on it, including those with aftermarket or upfitter modification. The field of view extended area is a 10 foot by 20 foot space directly behind the vehicle. Though validation of the standard is done by the manufacturer, dealer, or upfitter; we are glad to assist our customers with camera choice and placement. Don't hesitate to reach out our compliance department in regards to the standard.

Note: The camera in this system must be installed between flush 20"-55" off the ground and in a range of 12" in either direction from the center of the vehicle in order to be compliant with FMVSS 111.



# Monitor Dimensions

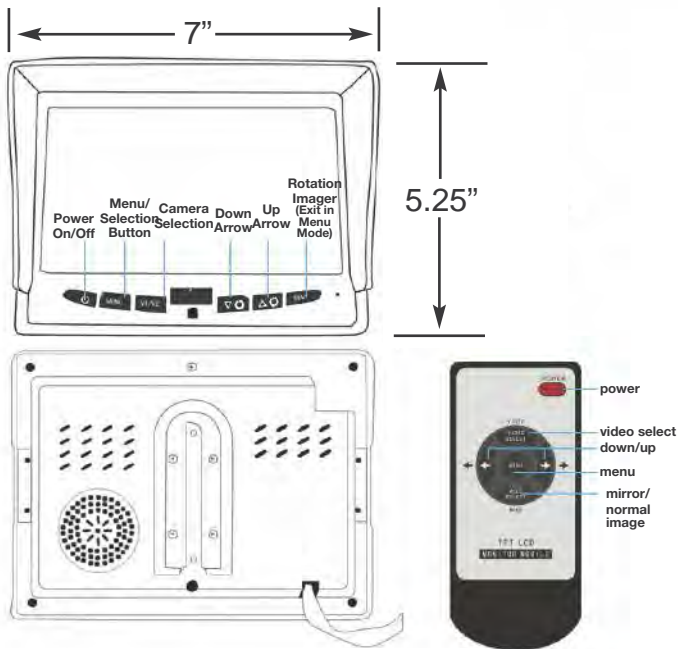

# Monitor Specifications

| TFT LCD Digital Monitor |                       |
|-------------------------|-----------------------|
| Screen Size             | 7"                    |
| Dot Resolution          | 800H x 3 (RGB) x 480V |
| Display Format          | 16:9 / 500:1          |
| Display Brightness      | 400cd/m <sup>2</sup>  |
| Viewing Angle           | U:50° / D:60° / R:70° |
| Video Input             | 3 channel             |
| Video Source            | 1Vp-p, 75□            |
| Power Supply            | DC 12V-24V (+/- 10%)  |
| Power Consumption       | 5W                    |
| Operating Temperature   | -30°C ~ +80° C        |
| Video System            | Auto NTSC/PAL         |
| Overall Dimensions      | 7"L x 5.25"H x 1"D    |
| Weight                  | 400G                  |
| Impact Rating           | 5G                    |
| Dot Pitch               | 0.192H x 0.1805V      |
| Sync System             | Internal              |

## Camera Dimensions

1.125" (L) x 1.06" (H) x 1.43" (D)



## Camera Specifications

|                       |                |
|-----------------------|----------------|
| Sensor                | 1/3 PC1099     |
| Active Array          | 960 X 480      |
| Viewing Angle         | 170°           |
| Resolution            | 700 TV Lines   |
| Minimum Light         | 0.5 Lux        |
| AGC                   | Auto           |
| BLC                   | Auto           |
| S/N Ratio             | More than 48dB |
| Video Output          | 1Vp-p 75Ω      |
| Voltage               | DC12V          |
| Operating Temperature | -40 ~ +70 °C   |

# Troubleshooting

## Monitor Displays Blue Screen & Displays No Signal

- Do a hard reset, unplug all cables, leave out for 1 minute and then re-connect them.
  - Check to ensure that the connection to the camera is tight.
  - Verify camera cable is plugged into port labeled Backup Camera
  - Verify that the blue positive trigger on power harness is put to power 12v+.
- If the problem still persists, verify that alternate ports work. If alternate ports do not work, remove Blue Trigger wire from 12V+ and select alternate channels.

## Monitor Will Not Power-Up (no backlight on power button)

- Check fuse
- Check 12v+ to monitor
- Check ground connection

## No Image On Screen

- Verify camera is on correct camera input
- Verify cable is connected to monitor
- Verify camera is connected to cable
- Connect known working camera and cable to monitor.
- Verify Blue trigger is receiving power

## One Year Warranty

Rear View Safety, Inc. warrants this product against material defects for a period of one year from date of purchase. We reserve the right to repair or replace any such defective unit at our sole discretion. Rear View Safety, Inc. is not responsible for a defect in the system as a result of misuse, improper installation, damage or mishandling of the electronic components. Rear View Safety, Inc. is not responsible for consequential damages of any kind.

This warranty is void if: defects in materials or workmanship or damages result from repairs or alterations which have been made or attempted by others or the unauthorized use of nonconforming parts; the damage is due to normal wear and tear, this damage is due to abuse, improper maintenance, neglect or accident; or the damage is due to use of the Rear View Safety, Inc. system after partial failure or use with improper accessories.

## Warranty Performance

DURING THE ABOVE WARRANTY PERIOD, SHOULD YOUR REAR VIEW SAFETY PRODUCT EXHIBIT A DEFECT IN MATERIAL OR WORKMANSHIP, SUCH DEFECT WILL BE REPAIRED WHEN THE COMPLETE REAR VIEW SAFETY, INC. PRODUCT IS RETURNED, POSTAGE PREPAID AND INSURED, TO REAR VIEW SAFETY, INC. OTHER THAN THE POSTAGE AND INSURANCE REQUIREMENT, NO CHARGE WILL BE MADE FOR REPAIRS COVERED BY THIS WARRANTY.

## Warranty Disclaimers

NO WARRANTY, ORAL OR WRITTEN, EXPRESSED OR IMPLIED, OTHER THE ABOVE WARRANTY IS MADE WITH REGARD TO THIS REAR VIEW SAFETY, INC. REAR VIEW SAFETY, INC. DISCLAIMS ANY IMPLIED WARRANTY OR MERCHANTABILITY OR FITNESS FOR A PARTICULAR USE OR PURPOSE AND ALL OTHER WARRANTIES IN NO EVENT SHALL REAR VIEW SAFETY, INC. BE LIABLE FOR ANY INCIDENTAL, SPECIAL, CONSEQUENTIAL, OR PUNITIVE DAMAGES OR FOR ANY COSTS, ATTORNEY FEES, EXPENSES, LOSSES OR DELAYS ALLEGED TO BE AS A CONSEQUENCE OF ANY DAMAGE TO, FAILURE OF, OR DEFECT IN ANY PRODUCT INCLUDING, BUT NOT LIMITED TO, ANY CLAIMS FOR LOSS OF PROFITS.

## Disclaimer

Rear View Safety and/or its affiliates does not guarantee or promise that the user of our systems will not be in/part of an accident or otherwise not collide with an object and/or person. Our systems are not a substitute for careful and cautious driving or for the consistent adherence to all applicable traffic laws and motor vehicle safety regulations. The Rear View Safety products are not a substitute for rearview mirrors or for any other motor vehicle equipment mandated by law. Our camera systems have a limited field of vision and do not provide a comprehensive view of the rear or side area of the vehicle. Always make sure to look around your vehicle and use your mirrors to confirm rearward clearance and that your vehicle can maneuver safely. Rear View Safety and/or its affiliates shall have no responsibility or liability for damage and/or injury resulting from accidents occurring with vehicles having some of Rear View Safety products installed and Rear View Safety and/or its affiliates, the manufacturer, distributor and seller shall not be liable for any injury, loss or damage, incidental or consequential, arising out of the use or intended use of the product. In no event shall Rear View Safety and/or its affiliates have any liability for any losses (whether direct or indirect, in contract, tort or otherwise) incurred in connection with the systems, including but not limited to damaged property, personal injury and/or loss of life. Neither shall Rear View Safety and/or its affiliates have any responsibility for any decision, action or inaction taken by any person in reliance on Rear View Safety systems, or for any delays, inaccuracies and/or errors in connection with our systems functions.







A Safe Fleet Brand

**If you have any questions  
about this product, contact:**

**Rear View Safety, Inc.  
1797 Atlantic Avenue  
Brooklyn, NY 11233  
800.764.1028**

**BETTER CAMERAS. BETTER SERVICE.  
IT'S OUR GUARANTEE.**

