



INSTALLATION AND OPERATION MANUAL

FVT/FVR10C1(M,S)1[/M], FVR20C2(M,S)2 & FVR40C4(M,S)4

SINGLE, DUAL OR QUAD-CHANNEL 10-BIT DIGITALLY ENCODED
SHORT-HAUL VIDEO AND CONTACT CLOSURE

**This manual serves the following
ComNet Model Numbers:**

FVT10C1M1/M
FVT10C1S1/M
FVT10C1M1
FVT10C1S1
FVR10C1M1
FVR10C1S1
FVR20C2M2
FVR20C2S2
FVR40C4M4
FVR40C4S4

The ComNet™ series video transmitters and receivers support the transmission of one, two, or four independent short-haul quality 10-bit digital video signals and one, two, or four contact closures in the direction of the video over multimode or single mode optical fibers. These modules are universally compatible with major CCTV camera manufacturers. The receivers are compatible with the FVT1(M,S)1/M* series single channel transmitters. Plug-and-play design ensures ease of installation and no electrical or optical adjustments are ever required.

Bi-color (Red/Green) LED indicators are provided for rapidly confirming operating status. Please see **Figure 10** on **Page 7** for LED explanations.

The FVT10C1(M,S)1/M units have a small footprint and are ideal for mounting where space is limited or can be mounted inside equipment housing. The remaining ComFit units may be either wall or rack-mounted. Please see **Figures A** and **B** on **Page 8** for mounting instructions.

* FVT1(M,S)1/M not available in North America.

FIGURE 1 - FVT10C1/M TRANSMITTER

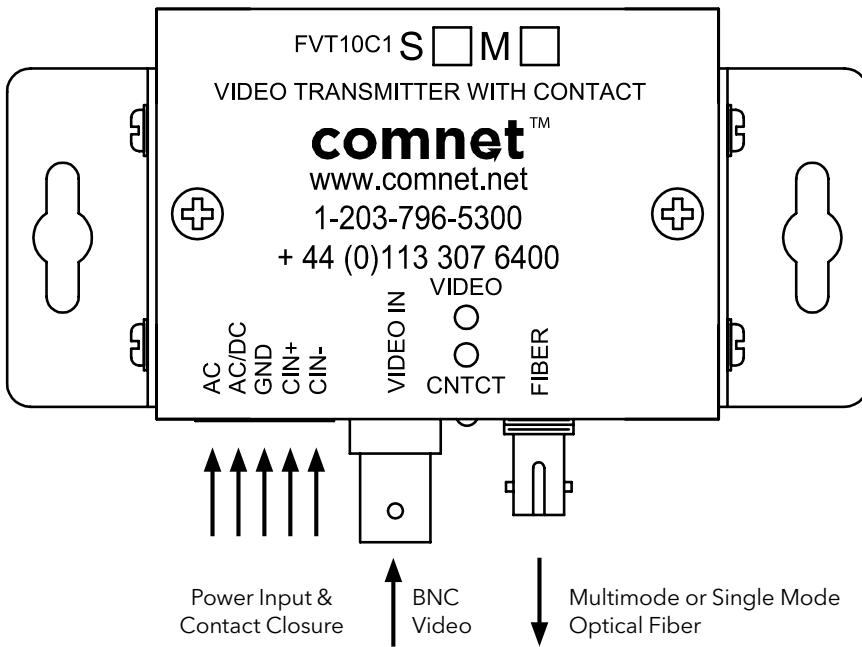

Power Supply:
 9 - 36VDC @ 2W
 OR
 12 - 24 VAC @ 2W

FIGURE 2 - FVT10C1/M TRANSMITTER

FRONT PANEL

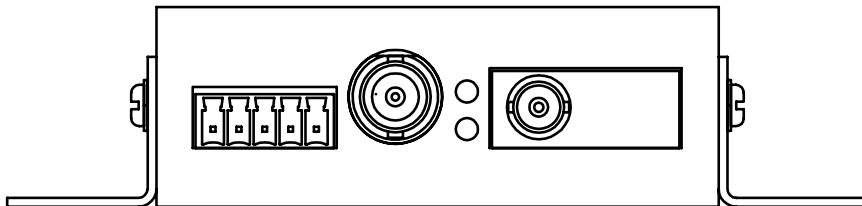

REAR PANEL

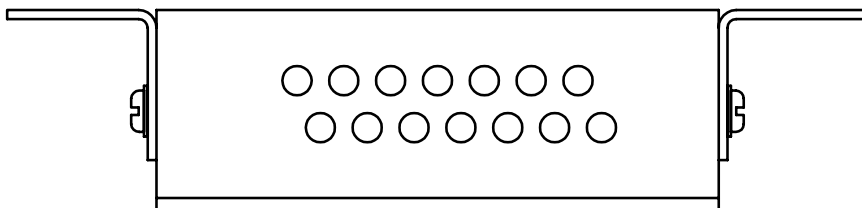

Mounting
 Bracket
 (Included)

FIGURE 2 - FVT10C1 TRANSMITTER

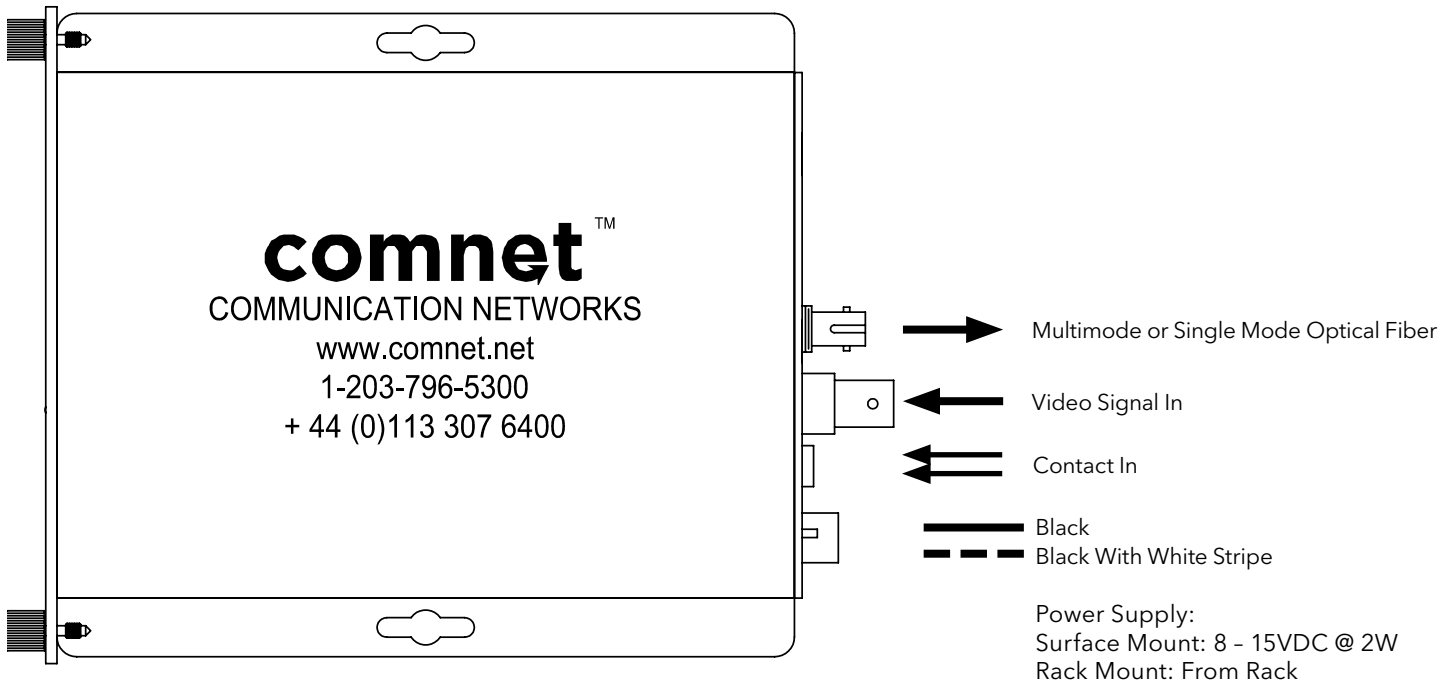

NOTE: Remove Electrical Connector for Rack Mount Units

FIGURE 3 - FVT10C1 TRANSMITTER

FRONT PANEL

REAR PANEL

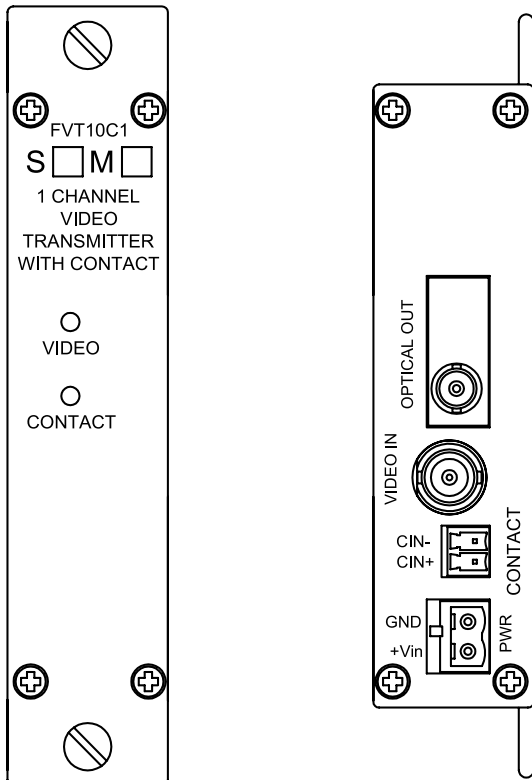
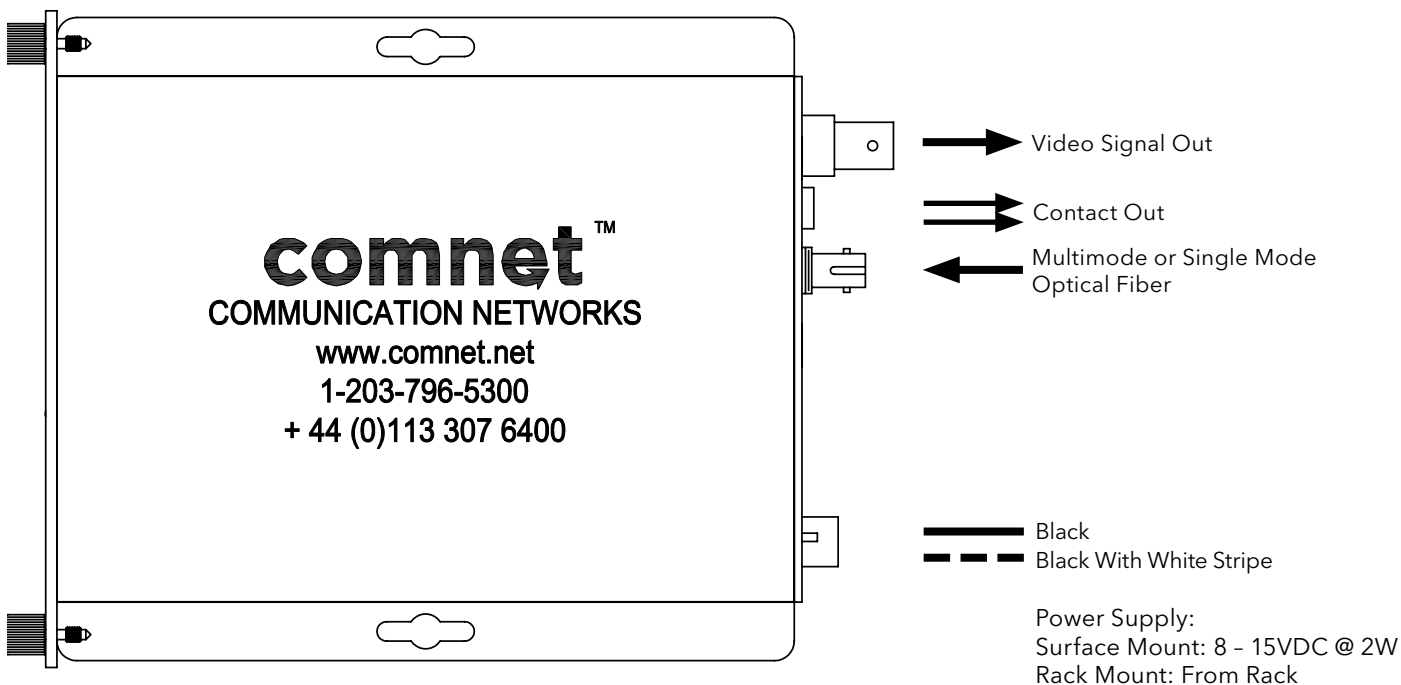

FIGURE 4 - FVR10C1 RECEIVER



NOTE: Remove Electrical Connector for Rack Mount Units

FIGURE 5 - FVR10C1 RECEIVER

FRONT PANEL

REAR PANEL

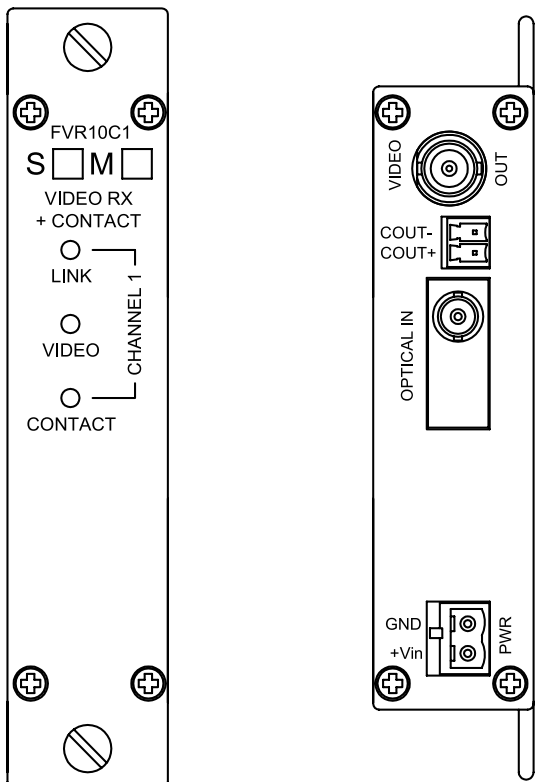
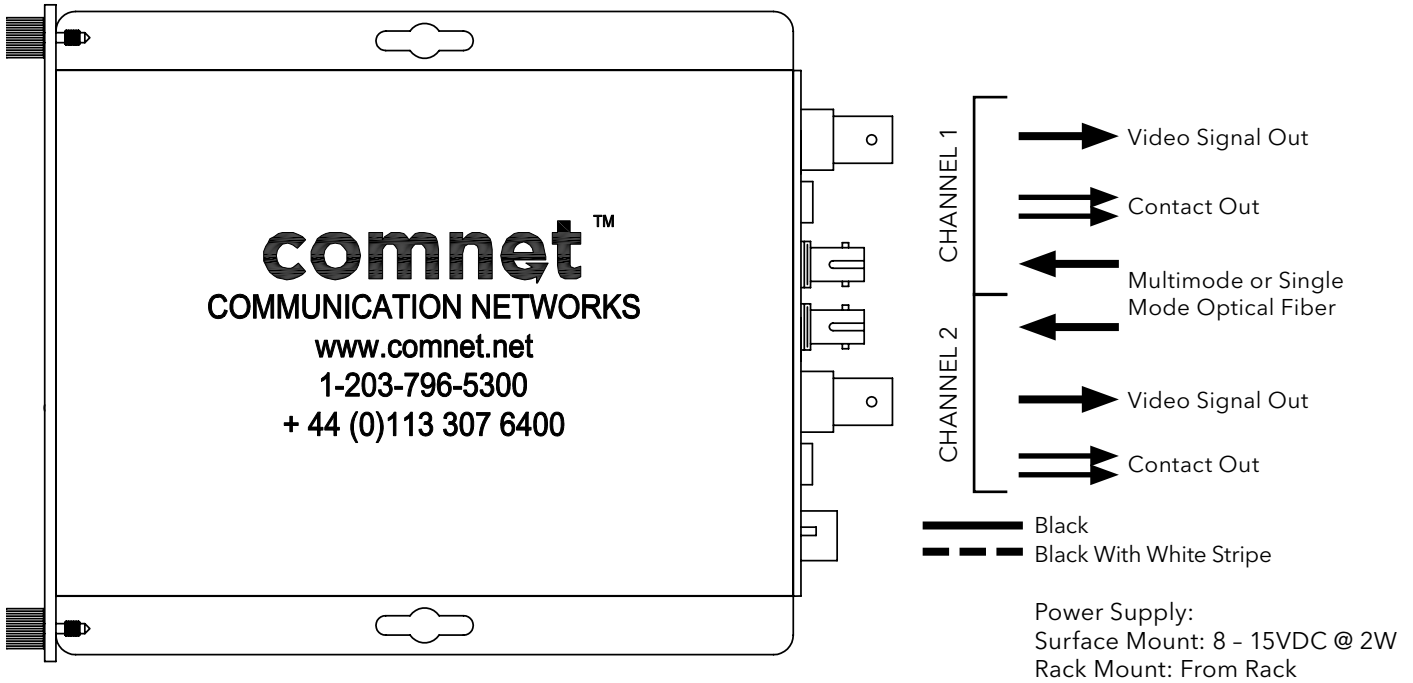

FIGURE 6 - FVR20C2 RECEIVER



NOTE: Remove Electrical Connector for Rack Mount Units

FIGURE 7 - FVR20C2 RECEIVER

FRONT PANEL

REAR PANEL

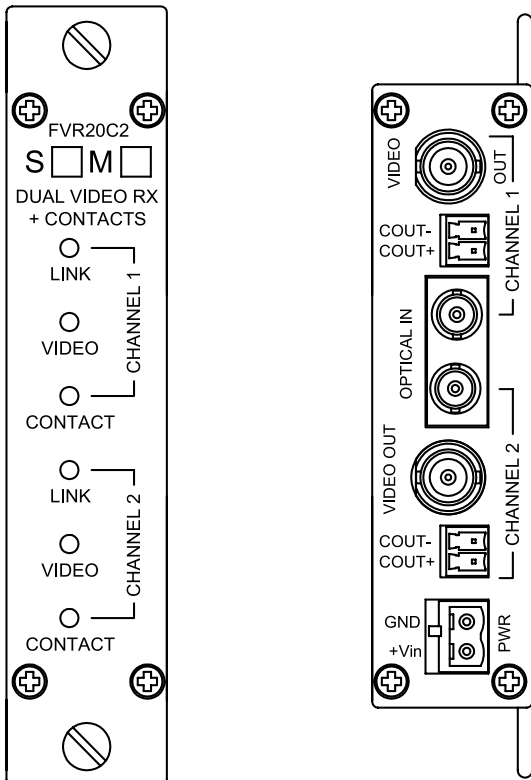
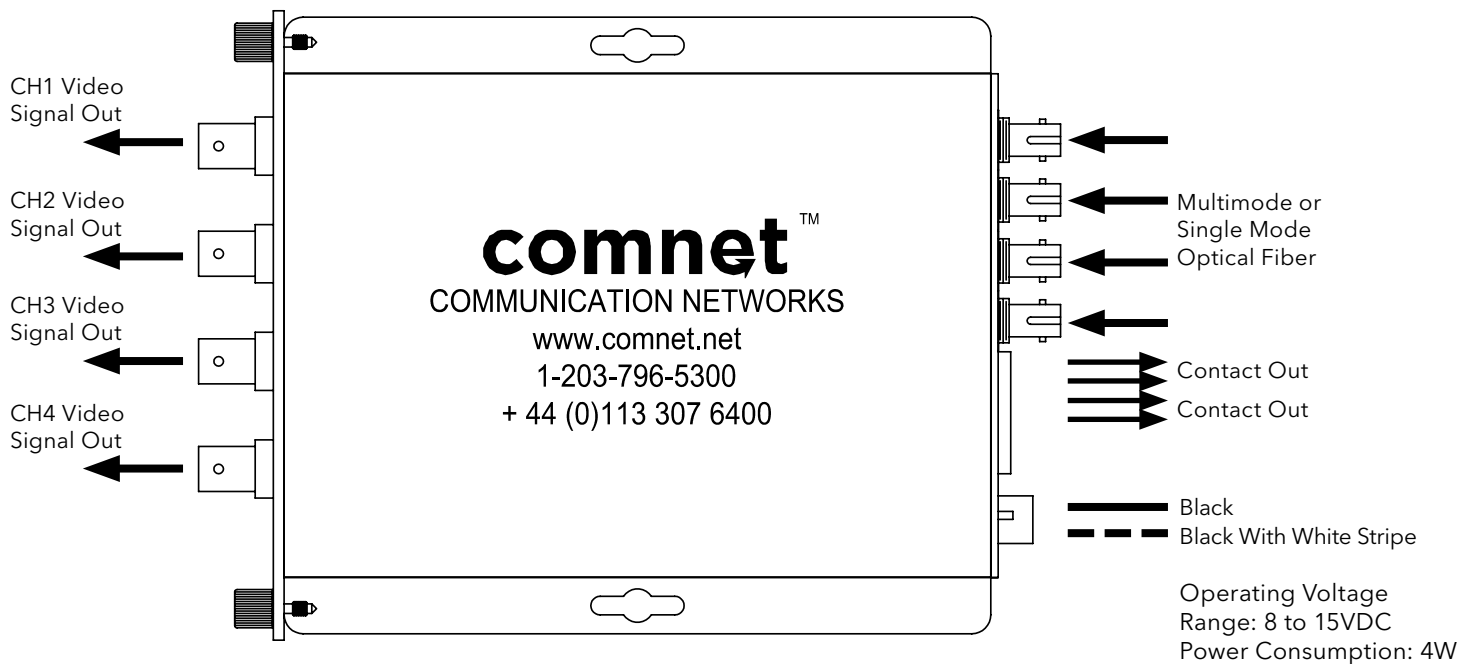

FIGURE 8 - FVR40C4 RECEIVER



NOTE: Remove Electrical Connector for Rack Mount Units

FIGURE 9 - FVR40C4 RECEIVER

FRONT PANEL

REAR PANEL

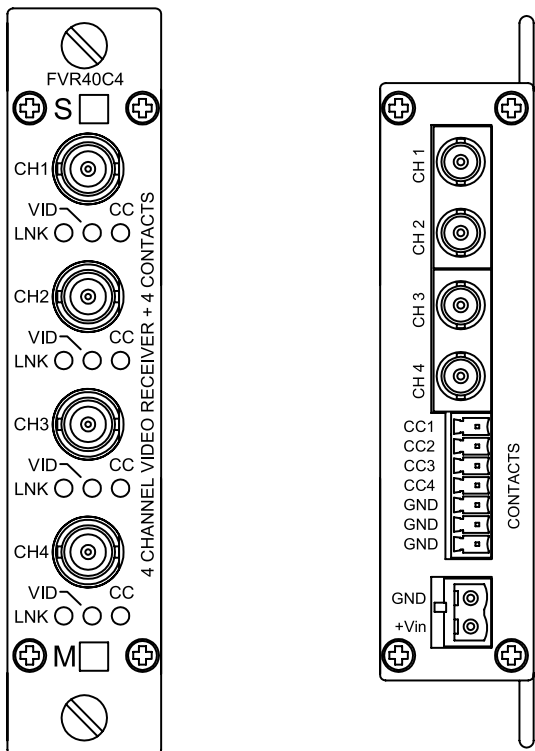

FIGURE 10 - LED INDICATORS

	LINK (RECEIVERS ONLY)	VIDEO	CONTACT*
GREEN	Communication link has been established over optical fiber	Video signal is present on the channel.	Contact input is closed.
RED	Communication link has not been established.	Video signal is not present on the channel.	-
OFF	Unit powered down.	Unit powered down.	Contact input is open.

* Contact Closure channels are not operational when used with the FVT1(M,S)1/M transmitters.

INSTALLATION CONSIDERATIONS

The FVT10C1(M,S)1/M is supplied as a Standalone/Surface Mount module. The remaining units covered in this manual are supplied as Standalone/Rack (ComFit) modules. Units should be installed in dry locations protected from extremes of temperature and humidity.

C1-US, C1-EU, C1-AU OR C1-CH CARD CAGE RACKS

CAUTION: Although the units are hot-swappable and may be installed without turning power off to the rack, ComNet recommends that the power supply be turned off and that the rack power supply is disconnected from any power source. **Note:** Remove electrical connector before installing in card cage rack.

1. Make sure that the card is oriented right side up, and slide it into the card guides in the rack until the edge connector at the back of the card seats in the corresponding slot in the rack's connector panel. Seating may require thumb pressure on the top and bottom of the card's front panel.

CAUTION: Take care not to press on any of the LEDs.

2. Tighten the two thumb screws on the card until the front panel of the card is seated against the front of the rack.

WARNING: Unit is to be used with a Listed Class 2 power supply.

IMPORTANT SAFEGUARDS:

- A) Elevated Operating Ambient** - If installed in a closed or multi-unit rack assembly, the operating ambient temperature of the rack environment may be greater than room ambient. Therefore, consideration should be given to installing the equipment in an environment compatible with the maximum ambient temperature (Tma) specified by the manufacturer.
- B) Reduced Air Flow** - Installation of the equipment in a rack should be such that the amount of air flow required for safe operation of the equipment is not compromised.



FIGURE A

Dimensions are for a ComNet™ FVT10C1/M module

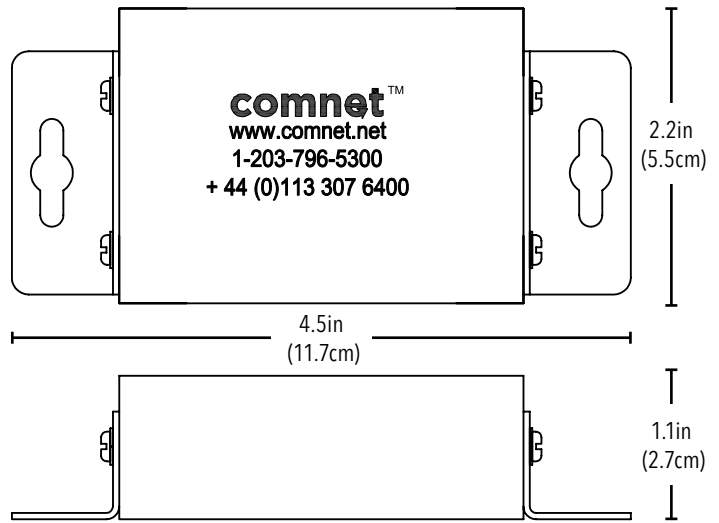
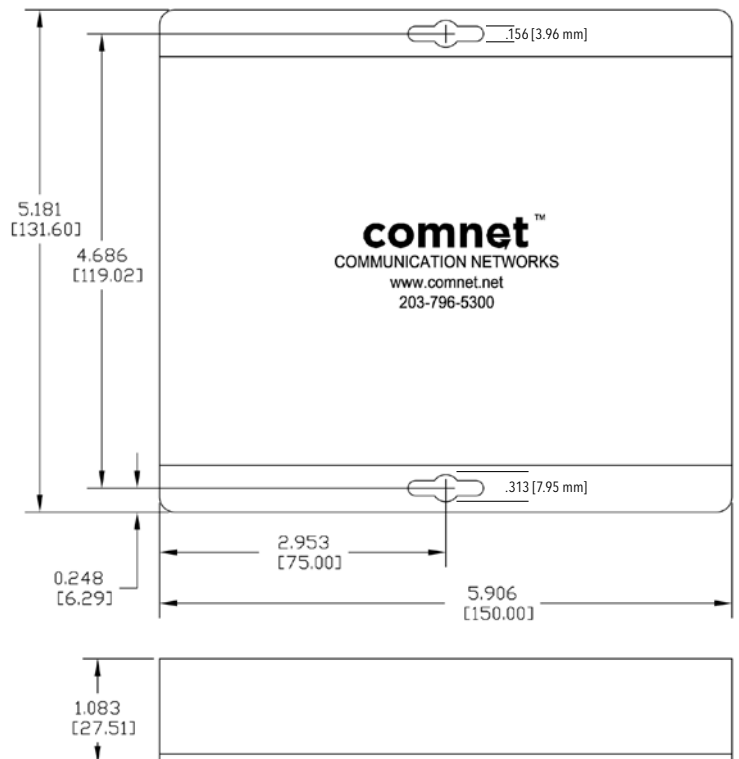

FIGURE B

Dimensions are for a standard ComNet™ one slot module



3 CORPORATE DRIVE | DANBURY, CT 06810 | USA
 T: 203.796.5300 | F: 203.796.5303 | TECH SUPPORT: 1.888.678.9427 | INFO@COMNET.NET
 8 TURNBERRY PARK ROAD | GILDERSOME | MORLEY | LEEDS, UK LS27 7LE
 T: +44 (0)113 307 6400 | F: +44 (0)113 253 7462 | INFO-EUROPE@COMNET.NET