



SmartVu **1.3 Megapixel Small Bullet With Varifocal Lens/IR**

Part of Dedicated Micros HD IP video surveillance cameras, the updated SmartVu 2015 range features the small bullet camera with 1/3" 1.3MP Aptina CMOS AR0130 sensor, varifocal lens and 30m IR distance.

Ideal for designing a cost effective HD solution combined with ease of install when coupled with any NetVu connected product, the SmartVu cameras are perfectly complimented by DM's latest, enhanced SD Advanced DVR/NVR portfolio. When configured with the SD Advanced NVR the SmartVu series contains a powerful suite of enterprise-scale capabilities protected by DM's award winning Closed IPTV.

Coming in all models bar the box camera, the updated SmartVu range offer the benefit of having remote focus capability. This mitigates the need for camera head focusing, saving both time and cost while, ensuring the highest quality IP installation.



Features & Benefits

1280x720p HD Resolution

2.8-12mm Motorized Varifocal Lens

Remote Focus Capable

MPEG4 / JPEG Compression

Closed IPTV – Via Switch

MultiMode – Save Up To 50% On Recording

Power Over Ethernet

Alarm Handling (With SD Advanced DVR/NVR)

30m IR Range (30 pcs)

IP66 Rated

Up to 10 Streams Generated

Video Motion Detection (VMD)

Ordering Information

Part Number	Description
DM/SV720SB/FR	SmartVu Small Bullet 720 30m IR AF

Dedicated Micros Technology Benefits

NetVu Remote Codec

When utilised with a NetVu connected server each camera can work as a remote codec. This is the most efficient means of connection to a DM Closed IPTV server as rather than simply request a stream from the IP camera, and then recode the stream as necessary the remote codec format makes individual requests for streams of frames directly from the codec in the camera.

Using this process the camera becomes an integral extension to the DVR/NVR distributing the processing requirements allowing a greater number of cameras to be connected and managed from one unit as stream communication becomes more efficient, reducing potential bottlenecks.

Ease Of Installation

Dedicated Micros technology removes the need for prior IT networking knowledge facilitating ease of install while ensuring the highest quality IP solution.

The updated SmartVu range offer remote zoom and auto focus meaning convenient focusing of the cameras is possible over the network, eliminating the need for physical fine tuning at each camera.

Port specific auto detect and auto configure cameras using Closed IPTV

A shared user interface helps minimise operator training whilst powerful features such as direct configuration of PTZ cameras and domes from connected DVR/NVRs helps reduce installation time providing benefits to both end user and installer/integrator.

Customisable

PowerScripting enables user customisation of complex, logical, alarm handling routines and integration of data from external sources. Extra value is created for the user through integration with business processes e.g. access control, building management, process control and manpower management. The result is a measurable return on investment tied in with operational process such as retail loss prevention.

MultiMode Recording And Streaming

Allows an event trigger from VMD, analytics and alarms to affect an instantaneous change in bit rate, frame rate and resolution. Full HD streams are generated when needed, e.g. for identification purposes, otherwise a standard definition stream saves up to 50% of the user's storage capacity.

Closed IPTV

All DM products are underpinned by the Closed IPTV technology. This encompasses a number of features to ensure security is at the forefront of the solution.

- Trusted Endpoints (a unique secret signature that is shared with the switch and the NVR) ensure any attempt to interfere with the Closed IPTV network will trigger an immediate security alert.
- Removing access to the corporate network via an exposed endpoint (e.g. a camera)
- Restrict Multicast – No one network endpoint can gain access to video from any other cameras or endpoints on the network.
- Firewall settings – Prevents any endpoint from opening a connection to a TCP server on the network

Technical Drawing

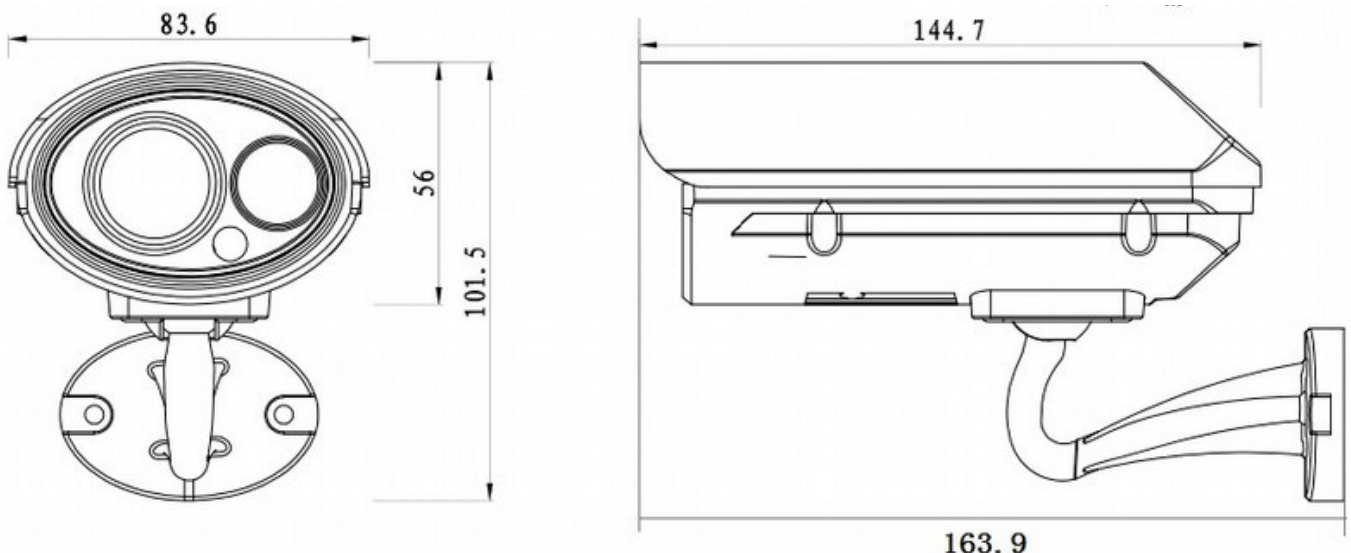

Technical Specification

Camera Specification	
Image Sensor	1/3" 1.3 Megapixel Progressive Scanning CMOS AR0130
Effective Pixels	1280x720p
AGC	Auto / Manual
Day/Night control	Auto
Day / Night	True Day / Night With ICR Filter
S/N Ratio	<50dB
Min. Illumination	Colour Mode 0.01UX(F1.2); B/W Mode 0.001LUX(F1.2)
Compression	MPEG4, JPEG, H.264 (Up To 10 Different Streaming Profiles)
IR Distance	30m
Interface	One 10M/100M Self Adaption Ethernet Port, RJ-45
Protocol	TCP/IP, HTTP, ICMP, SMTP, RTP, RTSP, SNMP, ARP, DDNS, DNS, POE, P2P,802, SCTP, NTP
Lens	
Focal Length	2.8-12mm
Lens	C/CS Motorised Varifocal
Image Format	1/3"
Focus	Auto Focus
Zoom	4x Optical Zoom
General Specifications	
Audio	N/A
Power	12V DC Terminal Input / PoE Class 3 9W
Electronic Shutter	Auto / User 1/5 - 1/50,000 ; 50/60Hz Software Selectable
Gain control	Auto / Fixed 8~102dB
Light Compensation	BLC /HLC
Network Protocols:	HTTP, TCP/IP, UDP/IP, RTSP, FTP, PoE, NTP. Unicast And Multicast Supported.
Operating Temperature	Operating: -30°C To 60°C / Storage: -30°C To 60°C
Operating Humidity	0~90%RH (Non-Condensing)
Approvals	CE / FCC / RoHS Compliant / IP66
Product Dimensions	144.7 x 83.6 x 56mm
Product Weight	0.55KG
Warranty	
	1 year plus additional free 1 year when product registered



V. MKT-SVU-SB001E © Copyright AD Group

Design and specifications are subject to change without notice E&O.E