

DS-2CD4232FWD-I(Z)(S)(H)

3MP WDR IR Bullet Network Camera

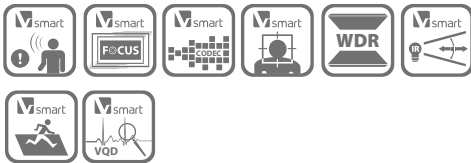

Key features

- Up to 2048 x 1536 high resolution
- Smart Codec
- 120dB WDR, 3D DNR
- Triple streams
- On-board storage, up to 64GB
- Smart Focus: Motorized VF lens (-Z)
- Smart VQD
- Smart Facial Detection
- Intrusion Detection
- Built-in heater
- Defog
- 8~32mm Motorized VF lens optional
- People Counting

Dimensions

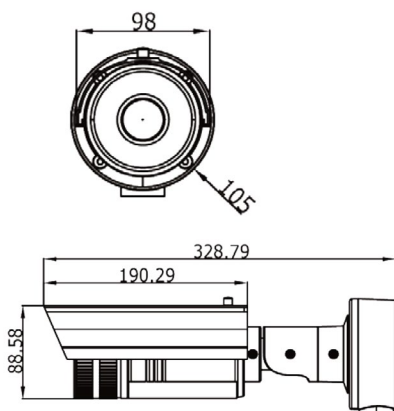

Available models

DS-2CD4232FWD-I, DS-2CD4232FWD-IS
 DS-2CD4232FWD-IZ, DS-2CD4232FWD-IZS
 DS-2CD4232FWD-IZH, DS-2CD4232FWD-IZHs

- * -Z: Motorized VF lens
- * -S: 1-ch audio I/O,
1-ch alarm I/O,
1-ch RS-485 interface
- * -H: Smart Heater

DS-2CD4232FWD-I(Z)(S)(H)	
Camera	
Image sensor	1/3" progressive scan CMOS
Min. illumination	0.1 lux@F1.2, AGC on, 0.14 lux@F1.4, AGC on, 0 lux with IR
Shutter time	1s ~ 1/100,000s
Slow shutter	Yes
Lens	2.8 ~ 12mm @F1.4, angle of view: 91.2° ~ 28.3° (-Z & non-Z model) (-Z: motorized VF lens) * 8~20mm @F1.6 lens (optional), angle of view: 33.2° ~ 13.8° (Option for -Z model) * 8~32mm @F1.4 lens, angle of view: 26° ~ 8.54° (option for -Z model)
Lens mount	Ø14
Auto iris	DC drive
Day & night	ICR (Auto/Schedule/Alarm Trigger)
Digital noise reduction	3D DNR
Wide dynamic range	120dB WDR
Compression standard	
Video compression	H.264 / MPEG4 / MJPEG
H.264 codec profile	Baseline profile / main profile / high profile
Video bit rate	32 Kbps ~ 16 Mbps
Audio compression	G.711 / G.722.1/ G.726 / MP2L2 *only for -S model
Audio bit rate	64Kbps(G.711) / 16Kbps(G.722.1) / 16Kbps(G.726) / 32-128Kbps(MP2L2)
Image	
Max. resolution	2048 x 1536
Frame rate	50 Hz: 20fps (2048 x 1536), 25fps (1920 x 1080), 25fps (1280 x 720) 60 Hz: 20fps (2048 x 1536), 30fps (1920 x 1080), 30fps (1280 x 720)
3rd stream	Independent setting, up to: 50Hz: 20fps (2048 x 1536), 60Hz: 20fps (2048 x 1536)
Image settings	Rotate mode, saturation, brightness, contrast, grayscale adjustable through client software or web browser
BLC	Yes, zone configurable
Defog	Yes
EIS	Yes
Picture overlay	128 x 128, BMP 24bit, zone configurable
ROI	Support
Network	
Network storage	NAS (Support NFS, SMB/CIFS)
Alarm trigger	Intrusion detection, Defocus detection, Motion detection, Face detection, line crossing detection, Dynamic analysis, Tampering alarm, Network disconnect, IP address conflict, Storage exception
Protocols	TCP/IP, ICMP, HTTP, HTTPS, FTP, DHCP, DNS, DDNS, RTP, RTSP, RTCP, PPPoE, NTP, UPnP, SMTP, SNMP, IGMP, 802.1X, QoS, IPv6, Bonjour
Security	User authentication, watermark, IP address filtering, anonymous access, reset
System compatibility	ONVIF, PSIA, CGI, ISAPI
Interface	
Communication interface	1 RJ45 10M / 100M ethernet port
On-board storage	Built-in Micro SD/SDHC/SDXC slot, up to 64 GB
Reset button	Yes
General	
Operating conditions	-30°C ~ 60°C (-22°F ~ 140°F), humidity 95% or less (non-condensing) -H: -40°C ~ 60°C (-40°F ~ 140°F), with smart heater on
Power supply	12 VDC ± 10%, PoE (802.3af)
Power consumption	Max. 11.5W -Z/-H: Max. 12.5W
IR range	Up to 30m Up to 80m IR with 8~20mm/8-32mm VF lens
Ingress protection	IP66
Dimensions	98 x 105 x 328.8 mm
Weight	1700 g (3.75 lbs)