

User Manual

IR Sensor

SIA-0010I/0010/0030/0060

Important Safety Instructions

1. Read these instructions.
2. Keep these instructions.
3. Heed all warnings.
4. Follow all instructions.
5. Do not use this apparatus near water.
6. Clean only with dry cloth.
7. Do not block any ventilation openings, Install in accordance with the manufacturer's instructions.
8. Do not install near any heat sources such as radiators, heat reasters, stoves, or other apparatus (including amplifiers) that produce heat.
9. Do not defeat the safety purpose of the polarized or grounding-type plug, A polarized plug has two blades with one wider than the other. A grounding type plug has two blades and a third grounding prong. The wide blade or the third prong are provided for your safety, If the provided plug does not fit into your outlet, consult an electrician for replacement of the obsolete outlet.
10. Protect the power cord from being walked on or pinched particularly at plugs, convenience receptacles, and the point where they exit from the apparatus.
11. Only use attachments/ accessories specified by the manufacturer.
12. Use only with the cart, stand, tripod, bracket, or table specified by the manufacturer, or sold with the apparatus. When a cart is used. Use caution when moving the cart/apparatus combination to avoid injury from tip-over.
13. Unplug this apparatus during lighting storms or when unused for long periods of time.
14. Refer all servicing to qualified service personnel. Servicing is required when the apparatus has been damaged in any way, such as power-supply cord or plug is damaged, liquid has been spilled or objects have fallen into the apparatus, the apparatus has been exposed to rain or moisture, does not operate normally, or has been dropped.



WARNING

TO REDUCE THE RISK OF FIRE OR ELECTRIC SHOCK, DO NOT EXPOSE THIS PRODUCT TO RAIN OR MOISTURE. DO NOT INSERT ANY METALLIC OBJECT THROUGH THE VENTILATION GRILLS OR OTHER OPENINGS ON THE EQUIPMENT.

Apparatus shall not be exposed to dripping or splashing and that no objects filled with liquids, such as vases, shall be placed on the apparatus

CAUTION

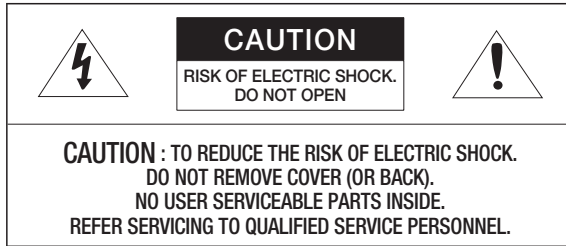

EXPLANATION OF GRAPHICAL SYMBOLS



The lightning flash with arrowhead symbol, within an equilateral triangle, is intended to alert the user to the presence of “dangerous voltage” within the product’s enclosure that may be of sufficient magnitude to constitute a risk of electric shock to persons.



The exclamation point within an equilateral triangle is intended to alert the user to the presence of important operating and maintenance (servicing) instructions in the literature accompanying the product.

Class I construction

An apparatus with CLASS I construction shall be connected to a MAINS socket outlet with a protective earthing connection.

Battery

Batteries(battery pack or batteries installed) shall not be exposed to excessive heat such as sunshine, fire or the like.

Disconnection Device

Disconnect the main plug from the apparatus, if it’s defected. And please call a repair man in your location.

When used outside of the U.S., it may be used HAR code with fittings of an approved agency is employed.

CAUTION

These servicing instructions are for use by qualified service personnel only.

To reduce the risk of electric shock do not perform any servicing other than that contained in the operating instructions unless you are qualified to do so.

Please read the following recommend safety precautions carefully.

- Do not Place this apparatus on an uneven surface.
- Do not install on a surface where it is exposed to direct sunlight, near heating equipment or heavy cold area.
- Do not place this apparatus near.
- Do not attempt to service this apparatus yourself.
- Do not place a glass of water on the product.
- Do not install near any magnetic sources.
- Do not block any ventilation openings.
- Do not place heavy items on the product.

User's Manual is a guidance book how to use the products

The meaning of the using sign in the book is following

- Reference: in case of providing information for helping of product's usages
- Notice: If there's any possibility to occur any damages for the goods and human caused by not following the instruction
- ✕ Please read this manual for the safety before using of goods and keep it in the safe place.

IR Sensor at a Glance

Cover

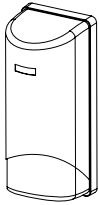

Receiver

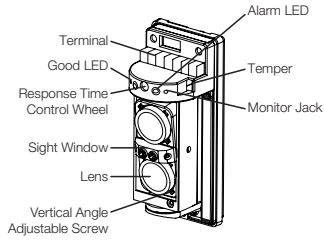

Transmitter

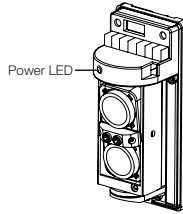

Multipurpose Bracket

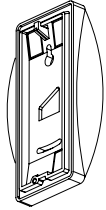

What's Included

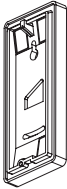

Injection bracket (x2)

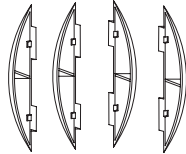

Injection Bracket Wing (x4)

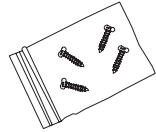

Screw (x4)



Steel Bracket x2 (optional)

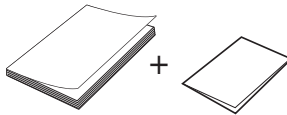

User Manual/Warranty Card

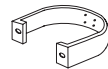

U-shaped Bracket x2 (optional)

Adjusting the response speed

You can adjust the response time by turning the response time control wheel left or right. Turning it left will speed up the response time; turn it right to slow down the time.

- The factory default is set to 250 msec.
- Full-speed run – 50 msec
- Fast walk – 100 msec
- Normal walk – 250 msec
- Slow walk – 350 msec
- Jump over a fence or obstacle – 500 msec

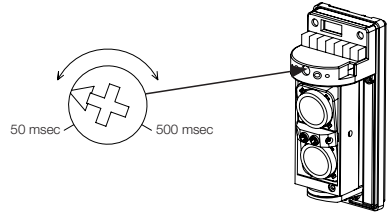

Installation Instructions

For best performance, you should consider the followings when placing, installing and keeping the product at a distance from the object.

- Do not expose it to a place where its light projector or light receiver is affected by a direct strong light such as sunlight or headlight. (below ± 2 is not allowed in the optical axis)
- Do not install it in an unstable, not properly secured place. (wire fence or unsecured pole is not allowed)
- Do not install it in a place where the infrared light is blocked due to a seasonal reason such as thick wood or bushes.
- Keep it away from the muddy water or sea water keeping splashing. (the infrared light is likely to be blocked by the muddy water or sea water)

Installation

To mount on the wall

1. Loosen the screw to remove the cover of the sensor as shown.

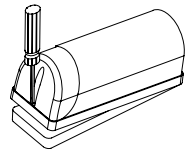

2. Insert the bracket wing on the side as shown.

- If using more than 1 bracket (max. height 15 cm)

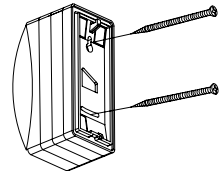
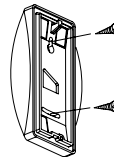
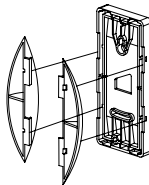

- Hook the upper hole of the sensor first and fit the lower hole into the wall bracket in the arrow direction.

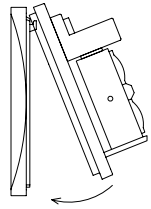

- Remove the slot-shaped filling on the rubber hole of the sensor and pull out the cables through the hole.

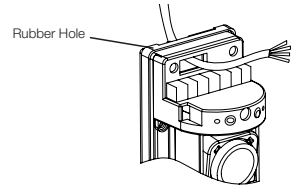

- When done, adjust the optical axis and insert the cover.

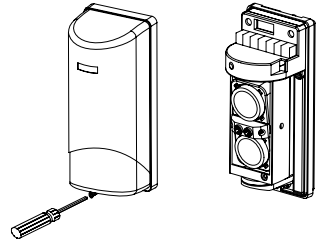

To attach to the pole

- Pull out the cables from the wiring hole of the pole; insert the U-shaped pole bracket to the pole.
- Attach the sensor to the bracket and arrange the cables as necessary. (same as in wall-mounting)

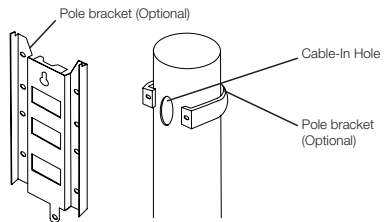

- Put the cover as original.

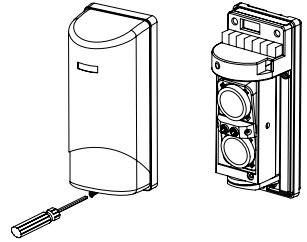

Adjusting the optical axis

- Connect both transmitter and receiver and turn them on.
- Look through the mirror of the sight and adjust the sensor so that the other sensor can be positioned in the center of the mirror.
 - You can use the left/right adjustable screw and the vertical adjustable screw of the reflector to refine your adjustment. (vertically $\pm 10^\circ$ & horizontally $\pm 90^\circ$)

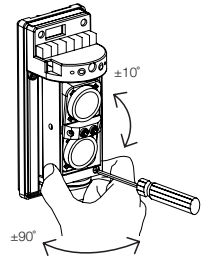
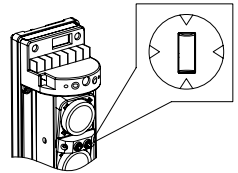

- Check the level of the light received from the monitor output signal. You can use the tester to measure the DC voltage and refine your adjustment.
- Check the output voltage of the tester and close the cover.

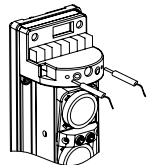

Output Voltage	Optical Axis Status
3.0V or higher	Good
2.9V or lower	To be adjusted

Troubleshooting

Problem	Reason	Action
The power indicator of the transmitter does not turn on.	<ol style="list-style-type: none"> 1. Power is not supplied. 2. Loose connection or short-circuited 	<ol style="list-style-type: none"> 1. Apply the power. 2. Check if the cables are properly connected.
Even if I block the infrared light, the alarm indicator of the receiver does not turn on.	<ol style="list-style-type: none"> 1. Power is not supplied. 2. Loose connection or short-circuited 3. The infrared light is incoming to the receiver after reflected by an object. 4. Two light sources are not properly blocked simultaneously. 	<ol style="list-style-type: none"> 1. Turn on the sensor. 2. Check if the cables are properly connected. 3. Remove the interruption object, or change the installation site or the orientation of the optical axis. 4. Block two light sources simultaneously.
The alarm indicator of the receiver will not turn off.	<ol style="list-style-type: none"> 1. The optical axis is dislocated. 2. There exists an obstacle between transmitter and receiver. 3. The cover of the transmitter or receiver has impurities on it. 	<ol style="list-style-type: none"> 1. Adjust the optical axis as necessary. 2. Remove the obstacle. 3. Wipe out the impurities with a soft cloth.
The alarm sounds intermittently.	<ol style="list-style-type: none"> 1. Disconnected cables 2. Fluctuation of the power voltage 3. There exists an obstacle between transmitter and receiver. 4. There exists a different strong power source around the transmitter or receiver. 5. The transmitter or receiver gets loose and unstable at its position. 6. The optical axis is dislocated. 7. The cover of the transmitter or receiver has impurities on it. 8. Sometimes a big bird or cat can block the light temporarily. 	<ol style="list-style-type: none"> 1. Check the connection status again. 2. Regulate the power voltage. 3. Remove the obstacle. 4. Change the wiring path. 5. Secure the pole or support. 6. Adjust the optical axis as necessary again. 7. Wipe out the impurities with a soft cloth. 8. Set the response time longer.

Wiring Diagram

Receiver

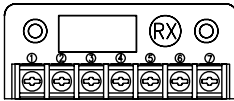

1. VCC : DC12V
2. GND
3. Normal Close
4. Common
5. Normal Open
6. Tamper
7. Tamper

Transmitter

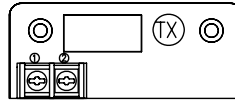

1. VCC : DC12V
2. GND

Specifications & Appearance

Specifications

Item	Description			
Model	SIA-0010I	SIA-0010	SIA-0030	SIA-0060
Work Range	Outdoor 10m	Outdoor 10m	Outdoor 30m	Outdoor 60m
Detection System	NIR Blocking System (Twin Beams)			
IR Light	IR LED			
Response Time	50 ~ 500 ms			
Power Voltage	DC 12V(±15%)			
AGC Voltage	Alarm: 2.0V or less, Ready: 2.1~2.9V, Good: 3.0V or higher			
Current Consumption	Receiver: 19mA, Transmitter: 22mA (max)			
Alarm Out	Dry contact relay output 1C (COM, N.C/N.O) Reset: Interruption time + off-relay (approx. 1 sec)			
Temperature	-25°C ~ 60°C			
Temper Output	Dry contact, Micro SW (COM, N.C)			
Adjustment of Optical Axis	Horizontal: 180°(±90°), vertical: 20°(±10°)			
Bracket Type	Default: Wall-mount bracket, Optional: Pole-mount bracket			
Weight	454g			470g
Dustproof/Waterproof Rating	IP 65			

Appearance

Unit: mm

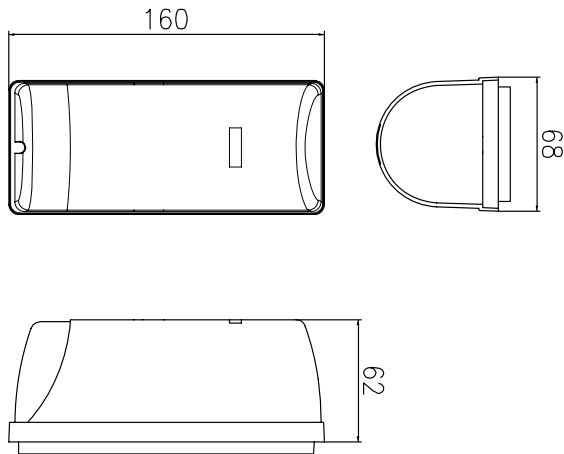

SAMSUNG TECHWIN



Correct Disposal of This Product (Waste Electrical & Electronic Equipment)

(Applicable in the European Union and other European countries with separate collection systems)

This marking on the product, accessories or literature indicates that the product and its electronic accessories (e.g. charger, headset, USB cable) should not be disposed of with other household waste at the end of their working life. To prevent possible harm to the environment or human health from uncontrolled waste disposal, please separate these items from other types of waste and recycle them responsibly to promote the sustainable reuse of material resources.

Household users should contact either the retailer where they purchased this product, or their local government office, for details of where and how they can take these items for environmentally safe recycling. Business users should contact their supplier and check the terms and conditions of the purchase contract. This product and its electronic accessories should not be mixed with other commercial wastes for disposal.