

# ESL 500N Series Smoke Detector Installation Instructions



**⚠ WARNING**  
This document is intended for licensed electricians/  
alarm installers. GE Interlogix cannot provide technical  
support to unqualified persons.

If you have questions, call GE Interlogix at 1-800-648-7424.

## Description

The ESL 500N Series conventional 2-wire and 4-wire photoelectric smoke detectors have intelligent software and digitally processed sensing capabilities. This intelligence coupled with the ESL patented optical sensing chamber means the ESL 500N Series quickly and accurately detects smoke. CleanMe® compatible software, self-diagnostics, and dust (drift) compensation are standard in every unit. The ESL 500N Series offers application flexibility with optional auxiliary relays, rate-of-rise/fixed temperature heat sensors, isolated heat sensors and/or 85dBa temporal 3 sounders.

**All models ship standard with the following features:**

### Detector/base lock

Discourages unauthorized removal of the smoke detector by requiring a screwdriver to remove the detector from the base.

### Self-diagnostics

Includes automatic sensitivity testing. Once a day and immediately upon first power up, each 500N Series detector performs a full diagnostic test that includes a dynamic test of the sensing chamber and internal electronics. This meets NFPA 72 field sensitivity testing requirements without the need for external meters.

### Drift compensation (dust compensation)

The detectors automatically adjust sensitivity, up to a maximum of 1.0%/ft., as the detectors become dirty.

### Automatic voltage range selection for UL 2-wire compatibility

The 2-wire 500N Series detectors automatically determine if the detector is connected to a 6/12V panel or a 12/24V panel. There are no switches to set.

**Depending on the model, the smoke detector provides the following features:**

### CleanMe®

Enables the control panel to receive a warning signal via a 505 module, or CleanMe compatible panel, indicating that the optical chamber needs to be replaced. This feature is available on the 500N Series 2-wire detectors only.

The 500N Series 2-wire detectors enable the CleanMe function by recognizing voltage polarity at installation. If the + and - terminal connections are reversed, the CleanMe function is enabled. New 500N Series detectors are compatible on the same loop with previous 500 Series detectors if proper wiring is observed. See Figure 5.

### Integral Temporal 3 Sounder

In the 500N models with sounder, a piezoelectric horn produces an interrupted 85dBa tone when the detector alarms or when the polarity is reversed. Sounder follows input voltage in reverse polarity.

In order for all sounders to activate when the panel alarms, the panel must reverse the supply voltage polarity to the loop on alarm. If the panel does not implement polarity reversal, an ESL 405 Polarity Reversal Relay Module must be used. (Refer to the installation instructions for the ESL 405 Polarity Reversal Relay Module.)

## Auxiliary and end-of-line relays

Auxiliary relays are form C and operate at 1A @ 30VDC to allow for the addition of auxiliary notification devices to the smoke loops. Products with an “R” in the suffix signify the auxiliary relay feature.

An end-of-line relay operates as a power supervision relay and is normally energized and will release with the loss of power. Products with an “E” in the suffix signify the end-of-line feature.

## Heat sensors

Some models come with both a rate-of-rise and fixed temperature heat sensors which allows the unit to detect changes in temperature that may signal a fire event. Models with an “XT” in the suffix have a heat sensor included.

Some models are available with an isolated heat sensor. If the unit senses a temperature change it will alert the panel and signal an alarm independent of smoke in the photoelectric chamber. The heat alarm output is on the alarm relay and the smoke alarm output is on the auxiliary relay. Models with an “H” in the suffix have an isolated heat sensor which is both rate-of-rise and fixed temperature.

## Convertible inputs

The 2-wire 500N Series can be converted using the ESL 505 module to a 4-wire input on the control panel. The 500N Series is UL Listed as compatible with the 505 module and will be fully UL compliant with any UL listed 24 VDC control panel and panels that do not operate below 12V. Up to 20 ESL 500N Series smoke detectors can be accommodated on each 505 module. See the 505 module installation instructions for more information.

## Compatibility

Please refer to the ESL Compatibility Index for a complete listing of control panels and proper identifiers. For a copy of the Compatibility Index, call 1-800-648-7424 or visit [www.sentrol.com](http://www.sentrol.com) for a copy to download. Remember, 4-wire smoke detectors do not require a compatibility listing.

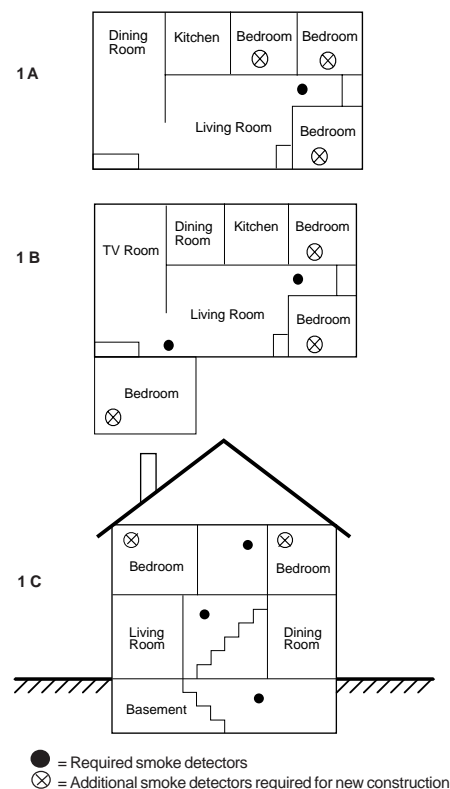

Figure 1. Detector placement

## Selecting a Location

Selecting a suitable location is critical to the operation of smoke detectors. This equipment should be installed in accordance with the National Fire Protection Association's (NFPA) Standard 72.

**A-8-1.2.1.a** *Where to Locate the Required Smoke Detectors in Existing Construction.* The major threat from fire in a family living unit occurs at night when everyone is asleep. The principal threat to persons in sleeping areas comes from fires in the remainder of the unit. Therefore, a smoke detector(s) is best located between the bedroom areas and the rest of the unit. In units with only one bedroom area on one floor, the smoke detector(s) should be located as shown in Figure 1 A.

In family living units with more than one bedroom area or with bedrooms on more than one floor, more than one smoke detector is required, as shown in Figure 1 B.

In addition to smoke detectors outside of the sleeping areas, the installation of a smoke detector on each additional story of the family living unit, including the basement, is required. These installations are shown in Figure 1 C. The living area smoke detector should be installed in the living room or near the stairway to the upper level, or in both locations. The basement smoke detector should be installed in close proximity to the stairway leading to the floor above. Where installed on an open-joisted ceiling, the detector should be placed on the bottom of the joists. The detector should be positioned relative to the stairway to intercept smoke coming from a fire in the basement before the smoke enters the stairway.

**A-8-1.2.1.b** *Where to Locate the Required Smoke Detectors in New Construction.* All of the smoke detectors specified in A-8-1.2.1.a for existing construction are required and, in addition, a smoke detector is required in each bedroom.

### **A-8-1.2.1.c** *Are More Smoke Detectors Desirable?*

The required number of smoke detectors might not provide reliable early warning protection for those areas separated by a door from the areas protected by the required smoke detectors. For this reason, it is recommended that the householder consider the use of additional smoke detectors for those areas for increased protection. The additional areas include the basement, bedrooms, dining room, furnace room, utility room, and hallways not protected by the required smoke detectors. The installation of smoke detectors in kitchens, attics (finished or unfinished), or garages is not normally recommended, as these locations occasionally experience conditions that can result in improper operation.

**Important:** Regulations pertaining to smoke detector installations vary from state to state. For more information, contact your local fire department or local authority having jurisdiction.

In addition to NFPA 72, use the following location guidelines to optimize performance and reduce the chance of false alarms from the detector:

- Locate ceiling-mounted smoke detectors in the center of a room or hallway at least 4 inches (10cm) from any walls or partitions.
- Locate wall-mounted smoke detectors so the top of the detector is 4 to 12 inches (10 to 30cm) below the ceiling.
- **Do not** locate detectors in or near bathrooms or kitchens.
- Locate in a suitable environment as follows:
  - Temperature between 32°F (0°C) and 100°F (37°C)
  - Humidity between 0 and 95% non-condensing
- Locate away from air conditioners, heating registers, and any other ventilation source that may interfere with smoke entering the detector.
- Mount smoke detectors on a firm permanent surface.

## Installing the Detector

All wiring must conform to the National Electric Code (NEC) and/or local codes having jurisdiction. Use 12 to 24 AWG (16 to 22AWG recommended) wire to install the detector.

1. If you are using the detector/base lock, remove the detector knockout and break off the tab on the mounting base. See Figure 2.
2. Remove the red plastic cover from the detector. The detector is shipped with a cover for protection against construction site dust.
3. Run system wiring to the detector location and mount electrical boxes if necessary. The detector fits standard single gang boxes and 3 1/2" and 4" round ceiling boxes.
4. Line up and attach the mounting base to the electrical box, wall or ceiling using the screws provided. Use the wall anchors if necessary. See Figure 3.
5. Strip the system wires and connect them to the appropriate terminals on the detector. See Figure 5.
6. Attach the detector to the mounting base as follows:
  - Line up the raised tab on the side of the detector with the arrow on the mounting base. See Figure 4.
  - Insert the smoke detector into the base and turn clockwise approximately 15 degrees. It should snap firmly into place.
7. Apply power and test the detector. See *Smoke Testing the Detector*.

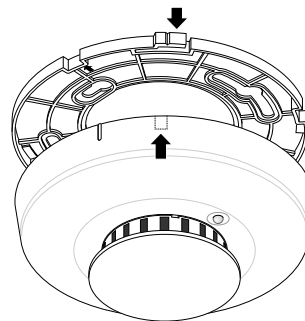

Figure 2. Detector/base lock

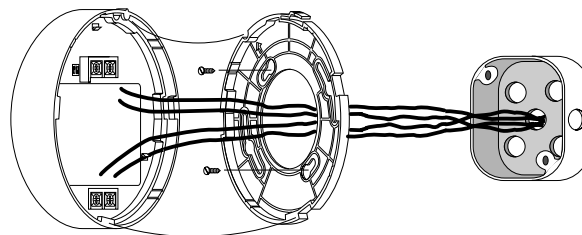

Figure 3. Detector installation

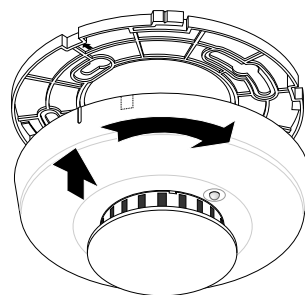
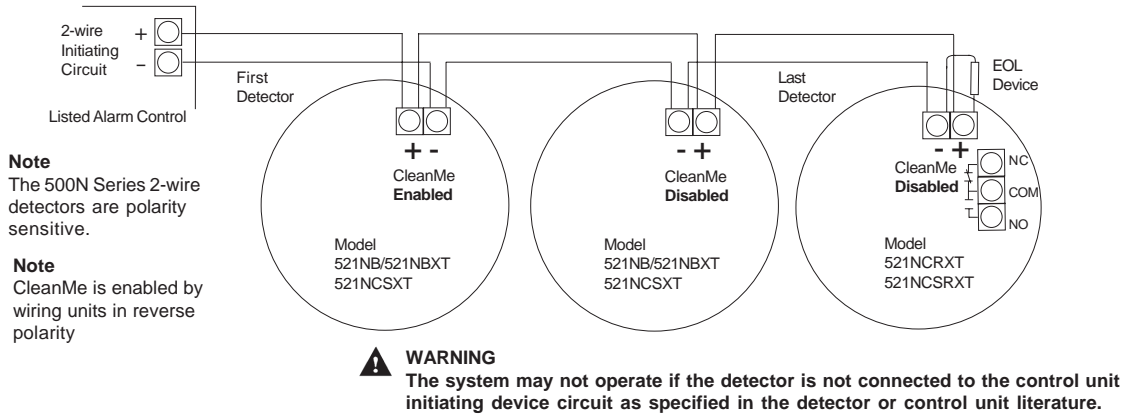
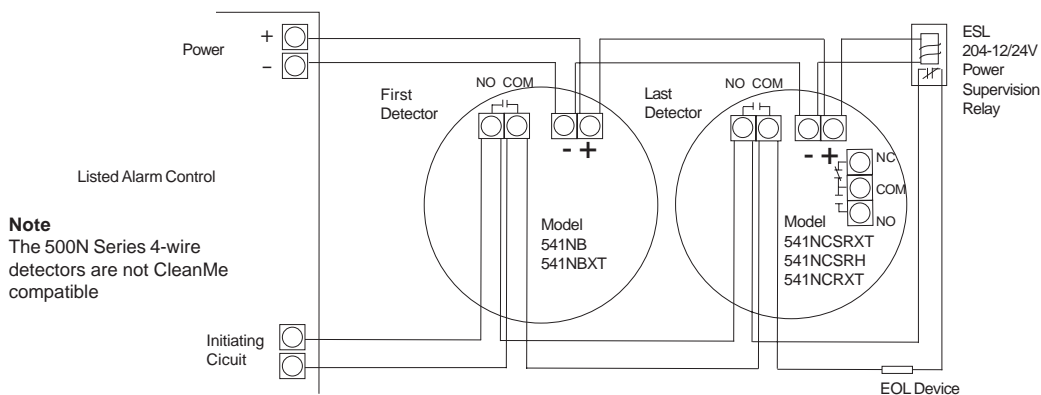

Figure 4. Mounting

### 500N Series 2-wire wiring diagram



### 500N Series 4-wire wiring diagram



### 500N Series 4-wire E model wiring diagram

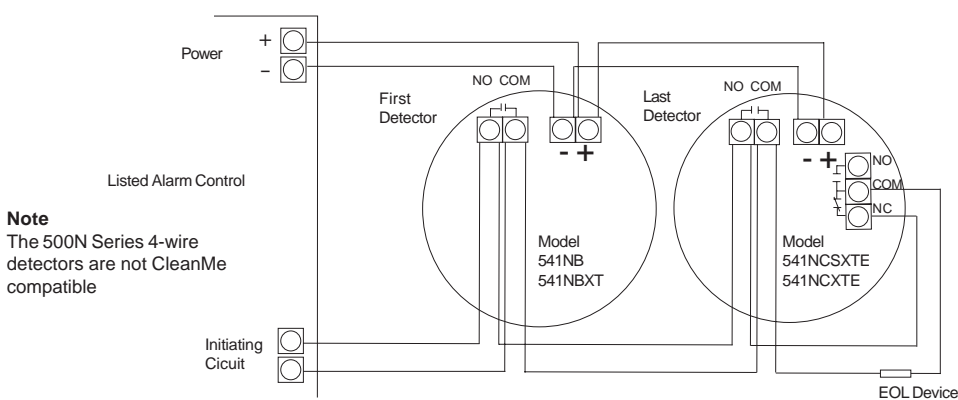

Figure 5. Wiring diagrams

## Smoke Testing the Detector

Smoke detectors should be tested in place annually using one of the following methods:

- A. Use Smoke! in a can® (product number SM-200), a canned aerosol simulated smoke and follow the directions on the can.
- B. Use the following steps to test the detector with smoke:
  1. Hold a smoldering punk or cotton wick close to the smoke entry openings.
  2. Gently direct the smoke into the detector for 20 seconds or until an alarm is indicated.

**Be sure to extinguish the smoke source after testing!** The detector LED should stay on and an alarm should be indicated at the control panel. Use the system reset switch to reset the detector.

## Removing the Detector

**To remove the detector from the mounting base,** grasp the detector and turn it counterclockwise approximately 15 degrees. The detector should snap off of the mounting base.

**To remove the detector from the mounting base when the detector/base lock is used,** insert a small screwdriver into the locking tab slot on the side of the base and press in while simultaneously turning the detector counterclockwise 15 degrees. See Figure 7.

## Understanding the LED

The LED on the detector indicates the status of the detector as follows:

**Flashing every 9 seconds** = Normal operation.

**On** = Detects smoke, sending an alarm.

**Off or flashing once every 1.5 seconds** = Trouble or maintenance is required. Test the detector. See *Testing the Detector Sensitivity*.

## Testing the Detector Sensitivity

The detector provides a sensitivity test that allows you to check the detector sensitivity using a test magnet and the LED indicator on the detector as follows:

1. Hold the test magnet up to the raised TEST letters on the top of the detector for 2 seconds. See Figure 6. Once the test starts, the alarm LED flashes one to nine times.
2. Count the number of times the LED flashes and use the following table to determine the status of the detector sensitivity and what action to take, if any.

Flashes	Indications	Action
1	Unserviceable hardware fault detected.	Reset unit and rerun sensitivity test. If the error persists, replace the unit.
2-3	Detector is becoming insensitive.	Clean the unit per instructions. Reset unit and rerun sensitivity test. If the error persists, replace the unit.
4-7	Detector is within normal sensitivity range.	N/A
8-9	Detector is becoming too sensitive.	Verify that the smoke chamber is snapped down securely. Clean the unit.

After the test:

**If the sensitivity is within limits and all other tests pass**, the detector goes into alarm and must be reset from the control panel.

**If the sensitivity is not within limits or an unserviceable hardware fault has been detected**, the detector LED flashes every 1.5 seconds until the detector is serviced.

## Cleaning the Detector

Clean the detector cover with a dry or damp (water) cloth as needed to keep it free from dust and dirt.

When necessary, clean the detector interior and **replace** the optical chamber as follows:

1. Disconnect the alarm notification appliances, service release devices and extinguishing systems.
2. Slide a flat-blade screwdriver into the slot on the detector cap and gently push the handle down to pry the cap up and off. See Figure 8.
3. Press in on the sides of the optical chamber and pull it up and away from the detector and discard. See Figure 9.
4. Use a vacuum to remove dust and dirt from the optical chamber base.
5. Line the new optical chamber up with the optical chamber base and snap it down into place.
6. Replace the detector cap as follows:
  - Line the tabs on the cap with the slots on the detector.
  - Insert the cap into the smoke detector and turn clockwise approximately 15 degrees. It should snap firmly into place.

7. Test the detector sensitivity (See *Testing the Detector Sensitivity*).
8. Reconnect all alarm notification appliances, service release devices and extinguishing systems.

**Important:** The control panel alarm and all auxiliary functions should be verified for a complete test of the system.

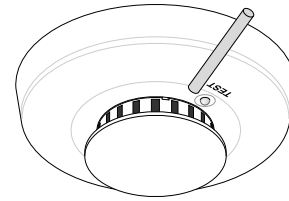

Figure 6. Testing the detector

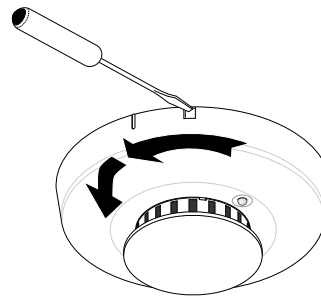

Figure 7. Unlocking the detector

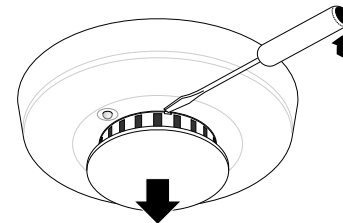

Figure 8. Removing the detector cap

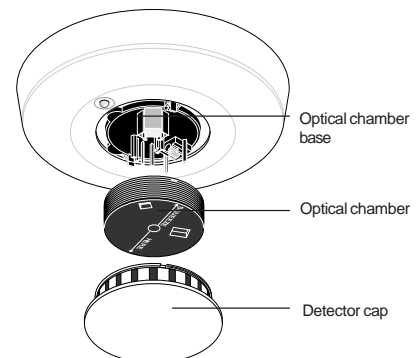

Figure 9. Removing the optical chamber

## Maintaining the Detector

These smoke detectors are designed for easy field service and maintenance. When installed and used properly, they require minimal maintenance.

The smoke detector should be tested monthly. See *Testing the Detector Sensitivity* and *Smoke Testing the Detector*.

## Fire Prevention and Escape

The purpose of an early warning smoke detector is to detect the presence of fire in its early stages and sound an alarm giving the occupants time to exit the premises safely.

### Avoid Fire Hazards

No detection device can protect life in all situations. Therefore, safeguards should be taken to avoid potentially dangerous situations as follows:

- **Do not** smoke in bed.
- **Do not** leave children home alone.
- **Never** clean with flammable liquids such as gasoline.
- Properly store materials. Use general good housekeeping techniques to keep your home neat and tidy. A cluttered basement, attic, or other storage area is an open invitation to fire.
- Use combustible materials and electrical appliances carefully and only for their intended uses. **Do not** overload electrical outlets.
- **Do not** store explosive and/or fast burning materials in your home.
- Even after proper precautions have been taken, fires can start.

### Be prepared.

### In Case of Fire

In the event of a fire, you should do the following:

- Leave immediately. Don't stop to pack or search for valuables.
- In heavy smoke, hold your breath and stay low, crawl if necessary. The clearest air is usually near the floor.
- If you have to go through a closed door, carefully feel the door and doorknob to see if undue heat is present. If they seem cool, brace your foot against the bottom of the door with your hip against the door and one hand against the top edge. Open it slightly. If a rush of hot air is felt, slam the door quickly and latch it. Unvented fire tends to build up considerable pressure. Be sure all members of the household realize and understand this danger.
- Use your neighbor's phone or a street fire alarm box to call the fire department. The job of extinguishing the fire should be left to the professionals.

### Be Prepared

Practice the following steps to prepare you and your family in the event of a fire:

- Perform fire drills regularly. Use them to assure recognition of an alarm signal.
- Draw a floor plan and show two exits from each room. It is important that children be instructed carefully, because they tend to hide in times of crisis.
- Establish one meeting place outside the home. Insist that everyone meet there during an alarm. This will eliminate the tragedy of someone reentering the house for a missing member who is actually safe.
- If you have children and/or physically challenged people residing in your household, use window decals to help emergency personnel identify the sleeping quarters of these individuals.

### WARNING

**Smoke detectors CANNOT provide warnings for fires resulting from explosions, smoking in bed or other furniture, ignition of flammable liquids, vapors and gases, children playing with matches or lighters.**

**Failure to properly install, test, and maintain a smoke detector system may cause it to fail resulting in loss of life and/or property.**

## Limited Warranty

ESL is a brand name of GE Interlogix, Inc. The manufacturer warrants this smoke detector to be free from defects in material and workmanship under conditions of normal use for a term of 3 years from the date of manufacture. During the warranty period, if a GE Interlogix product or any of its components becomes defective, it will be repaired or replaced without charge.

Out-of-warranty units will be repaired at the discretion of the manufacturer, if not, a card will be forwarded to the customer suggesting a replacement unit and the cost of that unit.

This warranty does not apply to units which have been subject to abuse, misuse, negligence or accident, or to which any modifications, alterations or repairs have been made or attempted.

This warranty is extended only to the original purchaser of the smoke detector and may be enforced only by such person. During the warranty period, if the detector or any warranted components thereof becomes defective, at the manufacturer's discretion, it will be replaced or repaired without charge if returned in accordance with the following instructions: Obtain a Return Authorization Number by calling 1-800-648-7422 or 503-692-4052, then carefully pack the unit in a well padded and insulated carton and return, postal charges prepaid to:

### Customer Service

**GE Interlogix, Inc.**

**12345 SW Leveton Drive**

**Tualatin, OR 97062-9938**

A note should be included advising the nature of the malfunction. Care must be exercised in the proper packing of detectors returned under this warranty as GE Interlogix will not be responsible for warranty repairs to equipment damaged because of improper packing.

**The above warranty is in lieu of all other express warranties, and implied warranties of merchantability and fitness for a particular purpose are limited in duration for a period of 3 years from the date of manufacture. Under no circumstances shall manufacturer be liable to the purchaser or any other person for incidental or consequential damages of any nature, including without limitation damages for personal injury or damages to property, and however occasioned, whether alleged as resulting from breach of warranty by manufacturer, the negligence of manufacturer or otherwise. Manufacturer's liability will in no event exceed the purchase price of the product. Some states do not allow limitations on how long an implied warranty lasts, or the exclusion or limitation of incidental or consequential damages, so the above limitations and exclusions may not apply to you. Unless a longer period is required by applicable law, any action against manufacturer in connection with this smoke alarm must be commenced within one year after the cause of action has occurred.**

No agent, employee or representative of the Manufacturer nor any other person is authorized to modify this warranty in any respect. Repair or replacement as stated above is the exclusive remedy of the purchase hereunder. This warranty gives you specific legal rights and you also have other rights which vary from state to state.

### WARNING

#### Limitations of smoke detectors

Smoke detectors are very reliable, but may not work under all conditions. No smoke detector provides total protection of life or property. Smoke detectors are not a substitute for life insurance.

#### Smoke detectors require a source of power to work.

This smoke detector will not operate and the alarm will not sound if the detector is not installed properly.

**Smoke detectors may not be heard.** A sound sleeper or someone who has taken drugs or alcohol may not awaken if the detector is installed outside a bedroom. Closed or partially closed doors and distance can block sound. This detector is not designed for the hearing impaired.

**Smoke detectors may not always activate and provide warning early enough.** Smoke detectors only activate when enough smoke reaches the detector. If a fire starts in a chimney, wall, roof, on the other side of closed doors, or on a different level of the property enough smoke may not reach the detector for it to alarm.

**Smoke detectors are a significant help in reducing loss, injury and even death. However, no matter how good a detection device is, nothing works perfectly under every circumstance and we must warn you that you cannot expect a smoke detector to ensure that you will never suffer any damage or injury.**

# Specifications

Voltage	for standard 6/12 V operation (6 to 20 VDC), polarity sensitive for standard 12/24 V operation (8.5 - 33 VDC), polarity sensitive
Maximum ripple pk-pk (6/12/24V)	10% (V pk-pk)
Typical average standby current	70 uA
Typical alarm current (6/12/24V)	up to 60mA maximum if not limited by control panel
Aux. relay contacts	1A @ 30 VDC; Form C
Alarm contacts	500mA @ 36 VDC (resistive)
Photoelectric sensitivity	2.0% + 1.08 - 1.02
Operating temperature	32 °F to 100 °F (0 °C to 37 °C)
Operating humidity range	0 to 95% non-condensing
RFI immunity	20V/m minimum; 0-1000MHz
Color	white head and base

Field wiring size	12-24 AWG (16 - 22 AWG recommended)
Electrical boxes	Fits standard single gang and 3 1/2" and 4" round ceiling electrical boxes
Detector packaging	10 detectors per carton
Heat detector specifications	rate-of-rise: 15°F/min and >105 °F (8.3 °C/min and >40.6 °C) fixed threshold: 135 °F (57.2 °C)
UL 2-wire compatibility identifiers:	S09A, S10A, S11A
Drift compensation adjustment	1.0%/ft. maximum
Detector head dimensions	5.5" (14.0cm) diameter; 2" (5.0cm) deep
Mounting dimensions	5.25" (13.3cm) diameter; 0.3" (0.8cm) deep
Reset time	1 second minimum
Listings:	CSFM,MEA State of Maryland UL 268, ULC-S531

C-UL US

# Product Ordering

Model	Description	Alarm Current (mA)	Reverse Polarity (mA)
521NB	2-wire, photoelectric, 6 - 33 VDC, S09A/S10A	20	-
521NBXT	2-wire, photoelectric, 6 - 33 VDC, fixed temp and rate-of-rise heat, S09A/S10A	20	-
521NCRXT	2-wire, photoelectric, 8.5-33 VDC, fixed temp and rate-of-rise heat, aux. relay, S11A	25	-
521NCSXT	2-wire, photoelectric, 8.5-33 VDC, fixed temp and rate-of-rise heat, temporal 3 sounder, S10A	30	13
521NCSRXT	2-wire, photoelectric, 8.5-33 VDC, fixed temp and rate-of-rise heat, aux. relay, temporal 3 sounder, S11A	35	13
541NB	4-wire, photoelectric, 6 - 33 VDC	20	-
541NBXT	4-wire, photoelectric, 6 - 33 VDC, fixed temp and rate-of-rise heat	20	-
541NCSRXT	4-wire, photoelectric, 8.5-33 VDC, fixed temp and rate-of-rise heat, aux. relay, temporal 3 sounder	35	13
541NCSXTE	4-wire, photoelectric, 8.5-33 VDC, fixed temp and rate-of-rise heat, built-in end-of-line relay, temporal 3 sounder	45	28
541NCSRH	4-wire, photoelectric, 8.5-33 VDC, isolated fixed temp and rate-of-rise heat, aux. relay, temporal 3 sounder, non-latching LED with auto reset	35	13
541NCRXT	4-wire, photoelectric, 8.5-33 VDC, fixed temp and rate-of-rise heat, aux. relay	25	-
541NCXTE	4-wire, photoelectric, 8.5-33 VDC, fixed temp and rate-of-rise heat, built-in end-of-line relay	25	-
541NCSXT	4-wire, photoelectric, 8.5-33 VDC, fixed temp and rate-of-rise heat, temporal 3 sounder	30	13

B	6 - 33V operation
C	8.5 - 33V operation
E	End-of-Line relay
H	Isolated rate-of-rise and fixed temp sensors
N	New style
R	Auxiliary relay
S	85dBa sounder
XT	Multi criteria algorithm, rate-of-rise and fixed temp. sensors

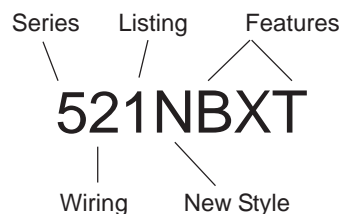

**GE Interlogix**

12345 SW Leveton Drive  
Tualatin, OR 97062  
www.interlogixsecurity.com  
www.sentrol.com

Phone: 503-692-4052  
USA & Canada: 800-547-2556  
Technical Service: 800-648-7424  
FaxBack: 800-483-2495

2266 Second Street North  
North St. Paul, MN 55109  
www.interlogixsecurity.com  
www.itii.com

Phone: 651-777-2690  
USA & Canada: 800-777-5485  
Technical Service: 800-648-7424