

GV-I/O Box 8 Ports

The GV-I/O Box 8 Ports provides 8 inputs and 8 relay outputs, and supports both DC and AC output voltages.

Key Features

- 8 inputs and 8 outputs are provided.
- Up to 9 pieces of GV-I/O Box 4/8/16 Ports can be chained together.
- A USB port is provided for PC connection, and it is only used for 30 DC output voltage.

System Requirements

The GV-I/O Box is listed as **XR21B1411 USB UART** under Windows Device Manager, GV-System version 8.5.7 or later is required.

To see how to check the device name under Windows Device Manager, refer to *Installing USB Driver* later in this Installation Guide.

Packing List

1. GV-I/O Box 8 Ports x 1
2. USB Cable (Type A to B) x 1
3. Power Adapter DC 12V x 1
4. Software DVD x 1

Note: The GV-I/O box 8 Ports comes with the option of an Ethernet module. See *Accessing GV-I/O Box over Networks* later in this Installation Guide.

Overview

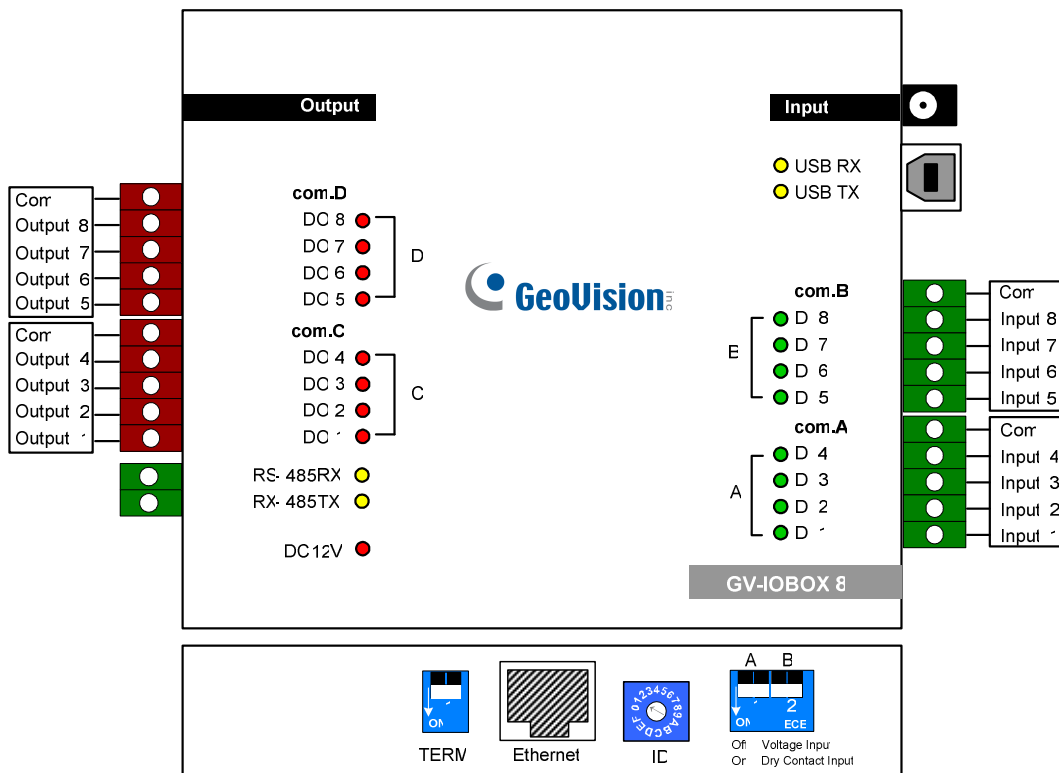

DIP Switch

The GV-I/O Box 8 Ports allows the use of mixing dry and wet contact devices together. The 8 inputs divided as four-in-one groups (A and B) are related to the 2 switches on the box for dry and wet contact.

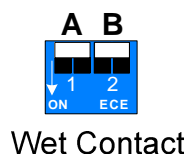

To change the inputs to different kind of contact, push the switch upward.

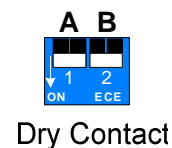

To change the inputs to different kind of contact, push the switch downward.

Note:

1. The RS-485 connectors do not support the conversion function from RS-485 to RS-232. Do not connect RS-485 devices, such as PTZ camera, to the connectors.
2. To add a GV-I/O Box 8 Ports to the GV-System of version 8.2, select **GVIO-USB (16)** from the Device drop-down list in the System Configure dialog box.

Connections to PC

There are three ways to connect a GV-I/O Box 8 Ports to the PC. Only one of the three methods can be used at a time.

- (1) **USB cable:** Use the USB cable to connect the PC.
- (2) **RS-485 wiring:** Through the option of GV-Hub, GV-COM, GV-NET Card or GV-NET/IO Card, use the RS-485 connectors to connect the PC. RS-485 connection is suitable for long distance wiring up to 600 m / 1968.5 ft.
- (3) **Network:** This is an optional function. See *Accessing GV-I/O Box over Networks* later in this Installation Guide.

1. Use the USB cable to connect one GV-I/O Box 8 Ports to the PC. **(Allowed for DC Output Voltage only)**

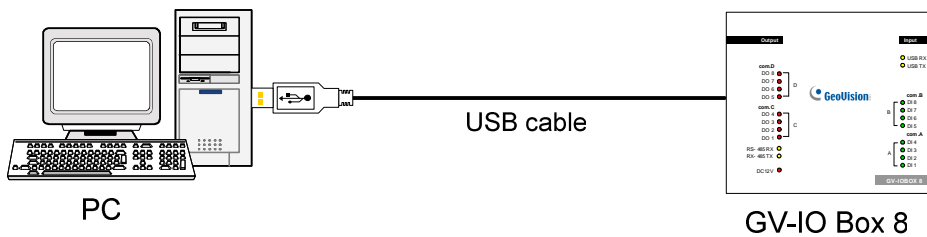

Note: It is required to install the USB driver. See *Installing USB Driver* later in this Installation Guide.

2. Use the RS-485 connectors to connect one GV-I/O Box 8 Ports with the PC. **(Allowed for AC/DC Output Voltage)**

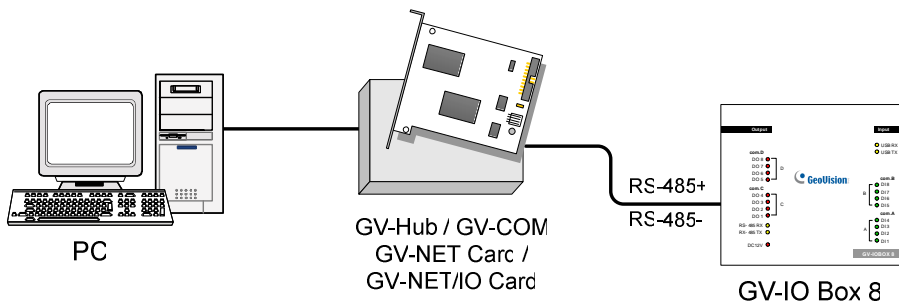

Installing USB Driver

To use the USB function, it is required to install the driver on the PC. Follow these steps to install the driver:

1. Insert the software DVD. It will run automatically and pop up a window.
2. Click **Install GeoVision USB Devices Driver**. This dialog box appears.

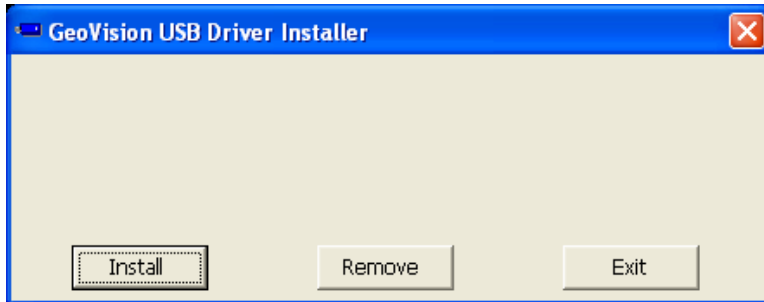

3. Click **Install** to install the drivers. When the installation is complete, this message will appear: *Install Successfully*.
4. Click **Exit** to close the dialog box and restart the PC.

To verify the drivers are installed correctly, go to Windows **Device Manager** after restarting the PC. Expanding the **Ports** field, you should see **XR21B1411 USB UART**. The COM number in the parenthesis indicates the COM port currently in use.



Note: If you unplug the GV-I/O Box 8 Ports from the PC and connect another GV-I/O Box to the same USB port, the COM port may still be changed. Access the Windows **Device Manager** again to look up the new COM port number.

Assigning Addresses to GV-I/O Box

You can connect any GV-I/O Box of 4, 8 and 16 ports together through RS-485 wiring. Up to 9 pieces of GV-I/O Box can be chained together to expand the I/O capacity. Use the ID switch (1~9) to assign addresses 1~9 to each GV-I/O Box.

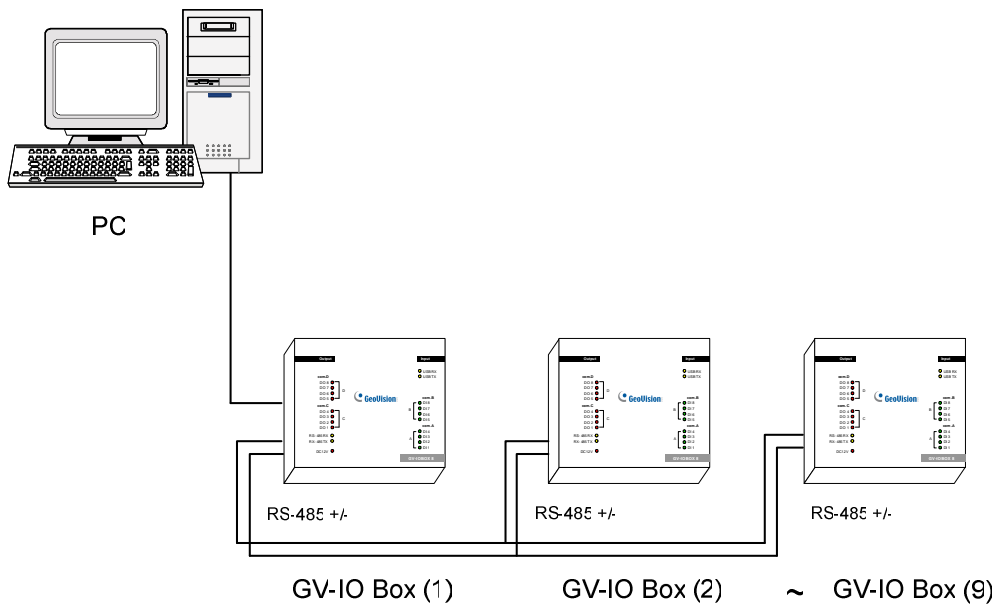

Note: The maximum distance for RS-485 connection is up to 600 m / 1968.5 ft.

ID Switch

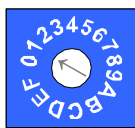

ID

1. Addresses 0 and A to F are NOT functional.
2. Assign the addresses when the power is off.
3. If you want to change the assigned address of the connected GV-I/O Box, set the switch to the new address, and then re-plug the power adaptor.

Extending Transmission over the Distance

When the transmission signals between the RS-485 communications become weak over the distance, switch on the Terminal Resistance Switches to maintain the signals. Three conditions below illustrate how the Terminal Resistance Switches should be switched on.

1. Multiple pieces of GV-I/O Box are connected with the PC through one single RS-485 cable.

After you connect multiple pieces of GV-I/O Box with the PC, switch on the Terminal Resistance Switches in the first and last connected pieces of GV-I/O Box.

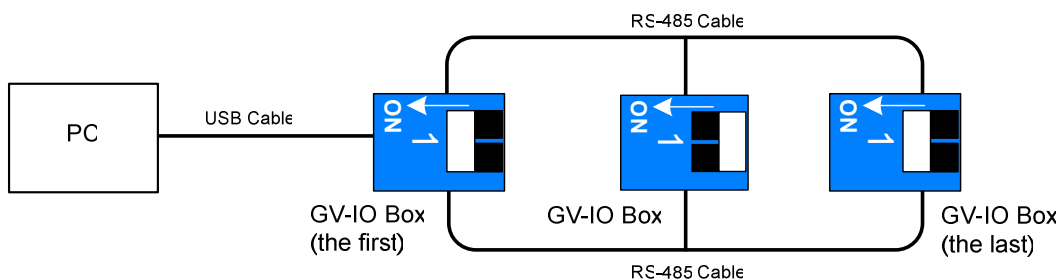

Note: If you connect **GV-IO Box 4 Ports V1.2** as the first device to the PC, do not use the USB cable. Instead, use the RS-485 cable and you need the optional device, GV-Hub, GV-COM, GV-NET Card or GV-NET/IO, to connect the RS-485 device to the PC.

2. Multiple pieces of GV-I/O Box are connected with the PC through a RS-485 converter.

After you connect multiple pieces of GV-I/O Box with the PC through a RS-485 converter, such as GV-NET/IO Card and GV-Hub, insert a Terminal Resistor in the converter and switch on the Terminal Resistance Switch of the last connected GV-I/O Box.

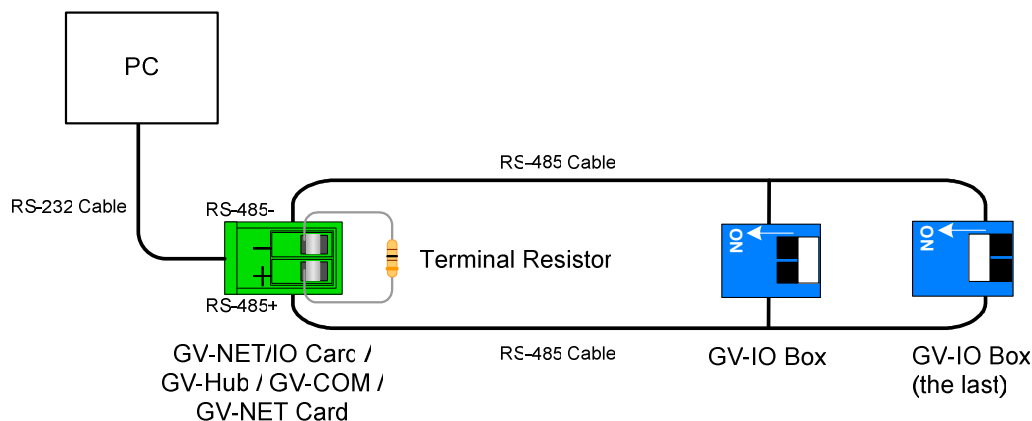

3. Multiple pieces of GV-I/O Box are connected with the PC through separate RS-485 cables.

After you connect multiple pieces of GV-I/O Box with the PC through separate RS-485 cables, switch on Terminal Resistance Switches of the connected piece of GV-I/O Box at the end of each cable.

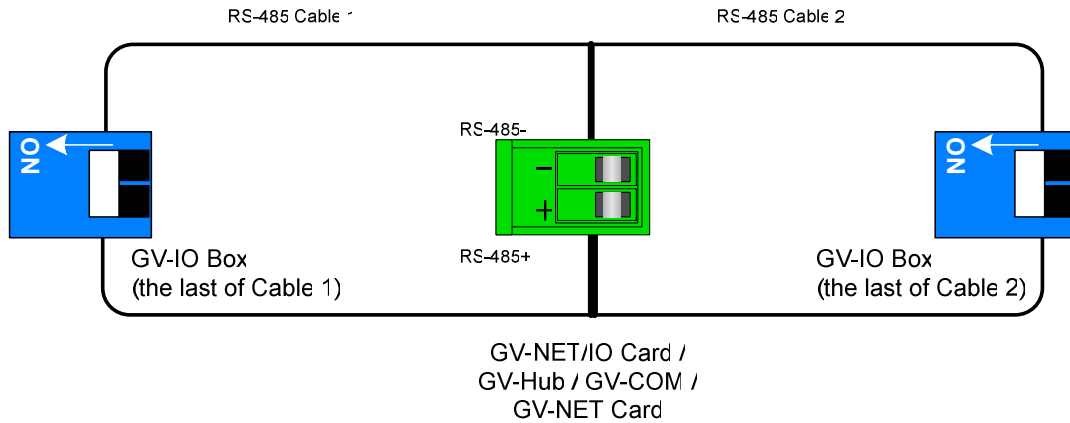

Terminal Resistance Switch

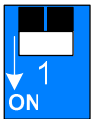

The default setting of the Switch is OFF. To switch on the Terminal Resistance Switch, push the switch downward.

Accessing GV-I/O Box 8 Ports over Networks

You can link the GV-I/O Box to GV-System, GV-GIS and Control Center over networks for I/O management.

Two network environments are supported: Fixed IP and DHCP. Depending on your network, choose Fixed IP for a static IP address or DHCP for a dynamic IP address such as those assigned by an ISP or other DHCP server.

GV-I/O Box is linked to GV-System by using the **Virtual I/O** function. Please note these specifications when GV-I/O Box works with GV-System:

1. GV-System supports up to 9 I/O modules which include real I/O devices and virtual I/O devices linked through networks.
2. Up to 5 connections, which include GV-System and any CMS applications, are allowed to control one GV-I/O Box.

Note:

1. GV-I/O Box has a default IP address of **192.168.0.100**. The computer used to set the IP address must be under the same network or subnet sequence assigned to the Box.
2. To link GV-I/O Box to GV-System, see *Virtual I/O Control*, Chapter 6 in *DVR User's Manual* on the Software DVD.

Fixed IP Connection

To assign GV-I/O Box to a fixed IP:

1. Open an Internet browser, and type the default IP address <https://192.168.0.100>. The login dialog box appears.
2. Type default value **admin** for both Username and Password, and click **OK**. This page appears.

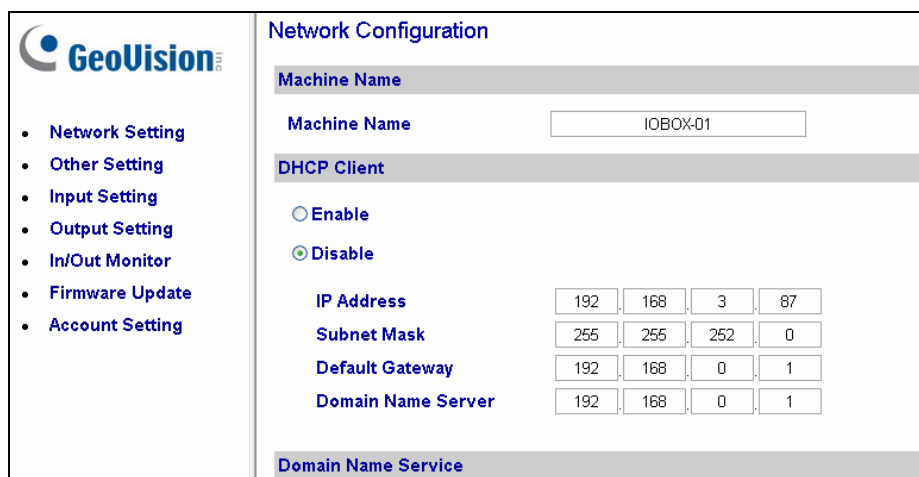

Network Configuration				
Machine Name				
Machine Name	<input type="text" value="IOBOX-01"/>			
DHCP Client				
	<input type="radio"/> Enable			
	<input checked="" type="radio"/> Disable			
IP Address	<input type="text" value="192"/>	<input type="text" value="168"/>	<input type="text" value="3"/>	<input type="text" value="87"/>
Subnet Mask	<input type="text" value="255"/>	<input type="text" value="255"/>	<input type="text" value="252"/>	<input type="text" value="0"/>
Default Gateway	<input type="text" value="192"/>	<input type="text" value="168"/>	<input type="text" value="0"/>	<input type="text" value="1"/>
Domain Name Server	<input type="text" value="192"/>	<input type="text" value="168"/>	<input type="text" value="0"/>	<input type="text" value="1"/>
Domain Name Service				

3. In the Machine Name field, edit the name of the connected GV-I/O Box.
4. Click **Disable**. Type the static IP address information, including IP Address, Subnet Mask, Default Gateway and Domain Name Server.
5. Click **Submit**. When the setting is complete, the Status field will indicate *Register Success*. Then GV-I/O Box can be accessed with this fixed IP address.

Note: If you like to use the domain name instead of IP address, you may use Domain Name Service as well. For details on domain name service, see *DHCP Connection* later in this Installation Guide.

DHCP Connection

DDNS (Dynamic Domain Name System) provides another way of accessing GV-I/O Box when using a dynamic IP from a DHCP server. DDNS assigns a domain name to GV-I/O Box so that GV servers can always access GV-I/O Box by using the domain name.

To enable the DDNS function, first you should apply for a domain name from the DDNS service provider's website. There are 2 providers listed in GV-I/O Box: **GeoVision DDNS Server** and **DynDNS.org**. To register at GeoVision DDNS Server, see the following instructions. For details on DynDNS, please consult them at www.dyndns.org.

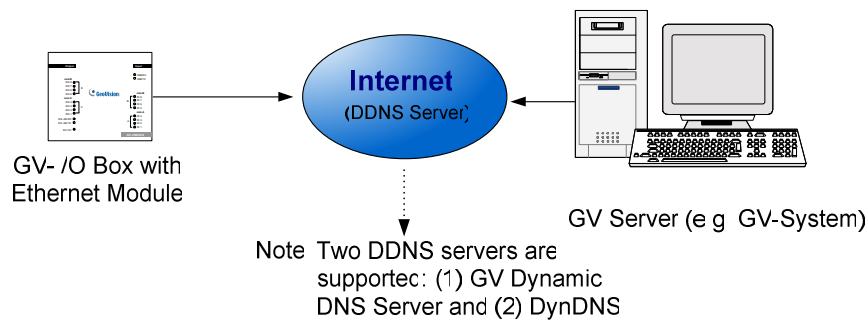

Registering a DDNS Domain Name

To obtain a domain name from the GeoVision DDNS Server:

1. Click the **GeoVision DDNS** button on the Network Configuration page. Or open an Internet browser, and type the Web address <http://ns.dipmap.com/register.aspx>. This page appears.

DynamicDNS01

Register

<p>Username: <input type="text" value="Somerset01"/></p> <p>Password: <input type="password" value="*****"/></p> <p>Re-type Password: <input type="password" value="*****"/></p>	<p>Username</p> <p>Username is 16-character maximum; username may not start with spaces or minus signs ("-"). Username will be your hostname.</p> <p>Password</p> <p>The password is case-sensitive.</p>	
<p>Enter the characters as they are shown in the box below. <input type="text" value="i8UCY"/></p> <div style="text-align: center;">  </div>		<p>Word Verification</p> <p>This step helps us prevent automated registrations.</p>
<input type="button" value="Send"/> <input type="button" value="Refresh"/>		

2. In the Username field, type a name. Username can be up to 16 characters with the choices of “a ~ z”, “0 ~9”, and “-”. Note that space or “-” cannot be used as the first character.
3. In the Password field, type a password. Passwords are case-sensitive and must be at least 6 characters. Type the password again in the Re-type Password field for confirmation.
4. In the Word Verification section, type the characters or numbers shown in the box. For example, type *i8UCY* in the required field. Word Verification is not case-sensitive.
5. Click the **Send** button. When the registration is complete, this page will appear. The **Hostname** is the domain name, consisting of the registered username and “dipmap.com”, e.g. somerset01.dipmap.com.

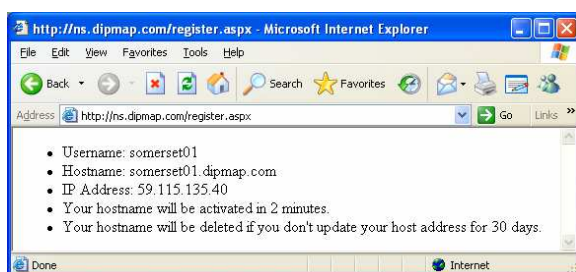

Note: The registered username will be invalid when it is not used for one month.

Configuring GV-I/O Box on Internet

After acquiring a domain name from the DDNS Server, you need to configure the domain name on GV-I/O Box so that GV servers can access GV-I/O Box by using the domain name on Internet.

1. Follow the Steps 1 to 2 in *Fixed IP Connection* section. The Network Configuration page appears.
2. Click **Enable**, and select **Send to DDNS**.
3. Type **Host Name**, **User Name** and **Password** that are registered on the DDNS Server. If you select GeoVision DDNS, the system will automatically bring up the Host Name.

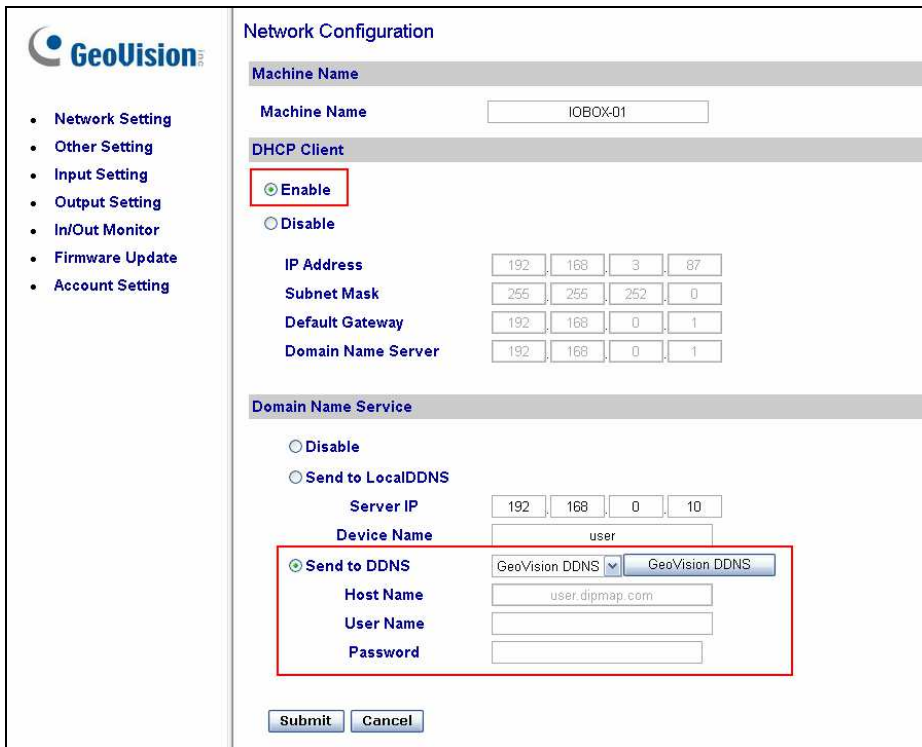

The screenshot shows the 'Network Configuration' page. On the left is a navigation menu with 'Network Setting' selected. The main content area is divided into sections: 'Machine Name' (IOBOX-01), 'DHCP Client' (radio buttons for 'Enable' and 'Disable', with 'Enable' selected), and 'Domain Name Service' (radio buttons for 'Disable', 'Send to LocalDDNS', and 'Send to DDNS', with 'Send to DDNS' selected). Under 'Send to DDNS', there is a dropdown menu set to 'GeoVision DDNS' and a button labeled 'GeoVision DDNS'. Below this, the 'Host Name' field is populated with 'user.dipmap.com', while 'User Name' and 'Password' fields are empty. At the bottom are 'Submit' and 'Cancel' buttons.

4. Click **Submit**. When the setting is complete, the Status field will indicate: Register Success. Then GV-I/O Box can be accessed with this domain name.

Other Setting

In the left menu, click **Other Setting**. This page appears.

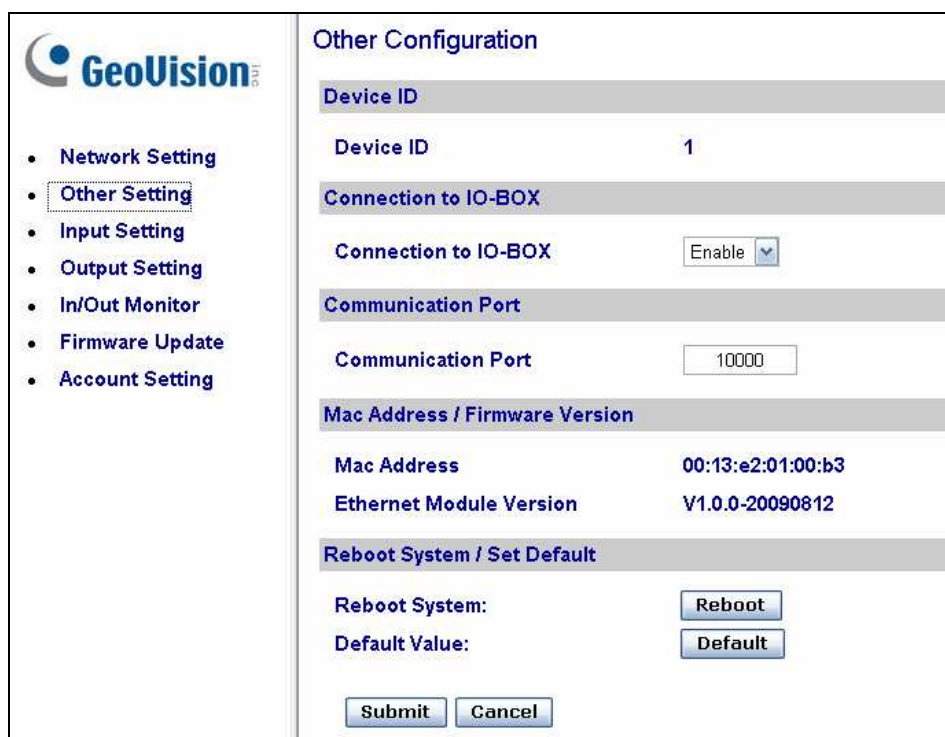

[Device ID] Indicates the current ID of the device.

[Connection to IO-BOX] Select **Enable** to use GV-I/O Box through network or select **Disable** to use GV-I/O Box through USB or RS-485 connection. GV-I/O Box cannot support more than one method simultaneously.

[Communication Port] Keeps the default port value **10000**.

[Mac Address/Firmware Version] Indicates the MAC address of the network medium and the Ethernet module version of GV-I/O Box.

[Reboot System/Set Default]

- **Reboot System:** Performs a warm boot of GV-I/O Box. This operation keeps the current configuration.
- **Default Value:** Resets all configuration parameters to their factory settings. This may take 5 seconds to complete.

Note: If you switch the connection from USB or RS-485 to network, first remove the USB or RS-485 cable from GV-I/O Box and then select **Enable** in this setting page; otherwise, the network connection will not function.

Input Setting

In the left menu, click Input Setting. This page appears.

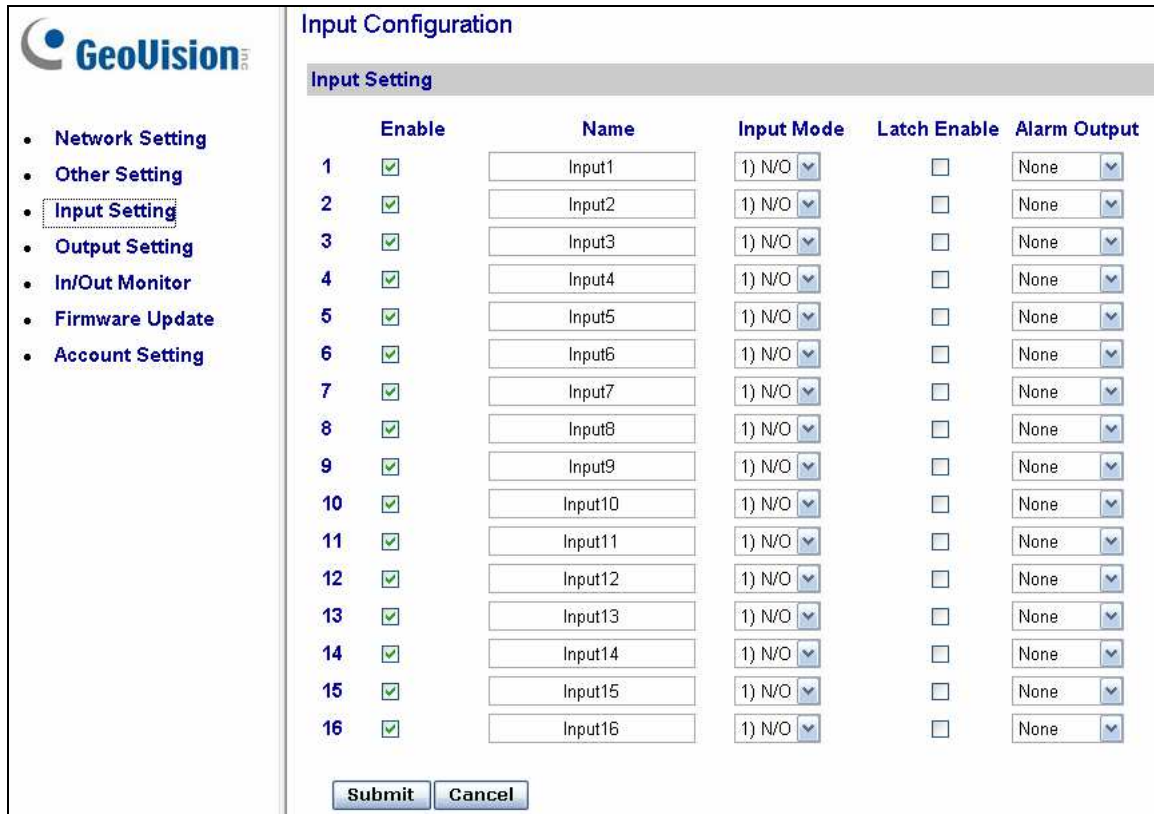

	Enable	Name	Input Mode	Latch Enable	Alarm Output
1	<input checked="" type="checkbox"/>	Input1	1) N/O	<input type="checkbox"/>	None
2	<input checked="" type="checkbox"/>	Input2	1) N/O	<input type="checkbox"/>	None
3	<input checked="" type="checkbox"/>	Input3	1) N/O	<input type="checkbox"/>	None
4	<input checked="" type="checkbox"/>	Input4	1) N/O	<input type="checkbox"/>	None
5	<input checked="" type="checkbox"/>	Input5	1) N/O	<input type="checkbox"/>	None
6	<input checked="" type="checkbox"/>	Input6	1) N/O	<input type="checkbox"/>	None
7	<input checked="" type="checkbox"/>	Input7	1) N/O	<input type="checkbox"/>	None
8	<input checked="" type="checkbox"/>	Input8	1) N/O	<input type="checkbox"/>	None
9	<input checked="" type="checkbox"/>	Input9	1) N/O	<input type="checkbox"/>	None
10	<input checked="" type="checkbox"/>	Input10	1) N/O	<input type="checkbox"/>	None
11	<input checked="" type="checkbox"/>	Input11	1) N/O	<input type="checkbox"/>	None
12	<input checked="" type="checkbox"/>	Input12	1) N/O	<input type="checkbox"/>	None
13	<input checked="" type="checkbox"/>	Input13	1) N/O	<input type="checkbox"/>	None
14	<input checked="" type="checkbox"/>	Input14	1) N/O	<input type="checkbox"/>	None
15	<input checked="" type="checkbox"/>	Input15	1) N/O	<input type="checkbox"/>	None
16	<input checked="" type="checkbox"/>	Input16	1) N/O	<input type="checkbox"/>	None

- **Enable:** Select to enable this Input function to be used by GV-I/O Box.
- **Name:** Edit the name of the Input.
- **Input Mode:** Configure the input to **NC** (normally closed) or **NO** (normally open) mode.
- **Enable Latch:** Instead of constant output alarm in N/O and N/C, the option provides a momentary alarm when triggered.
- **Alarm Output:** Select **None** for no alarm output, or select between **Output 1** and **Output 16** to trigger when the input is detected.

Click **Submit** button to save the changes, or click **Cancel** button to return the changes to its previous state.

Output Setting

In the left menu, click **Output Setting**. This page appears.

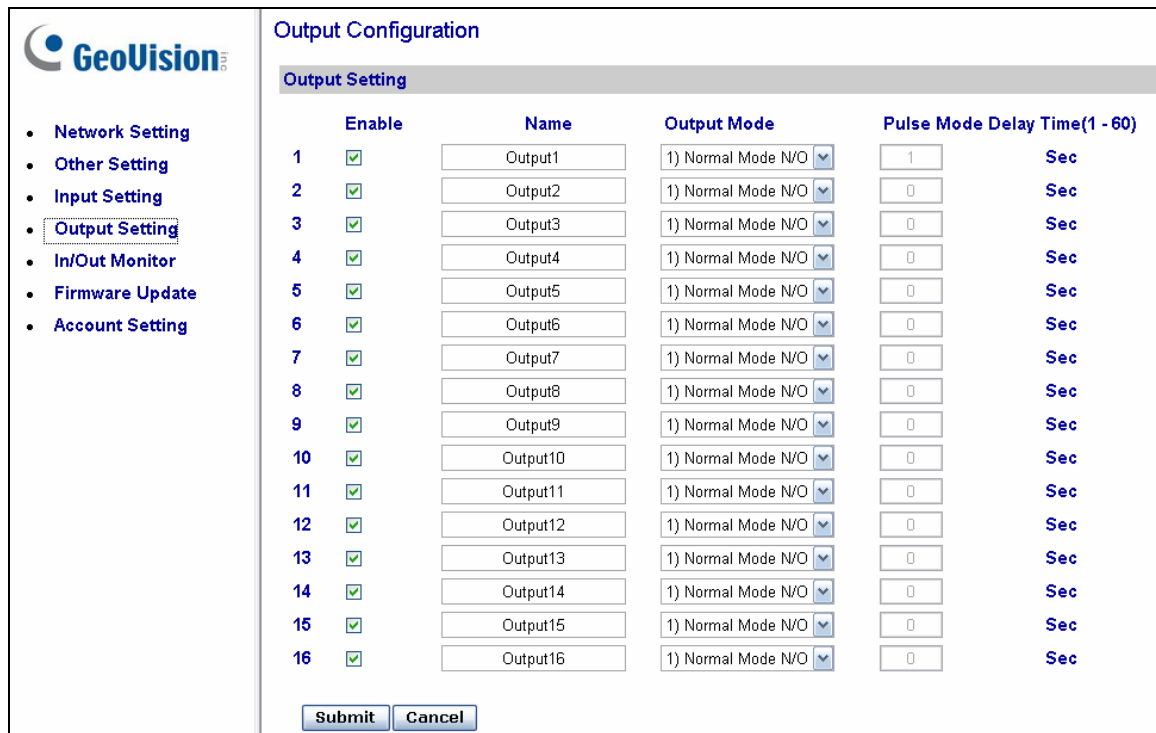

	Enable	Name	Output Mode	Pulse Mode Delay Time(1 - 60)	
1	<input checked="" type="checkbox"/>	Output1	1) Normal Mode N/O	1	Sec
2	<input checked="" type="checkbox"/>	Output2	1) Normal Mode N/O	0	Sec
3	<input checked="" type="checkbox"/>	Output3	1) Normal Mode N/O	0	Sec
4	<input checked="" type="checkbox"/>	Output4	1) Normal Mode N/O	0	Sec
5	<input checked="" type="checkbox"/>	Output5	1) Normal Mode N/O	0	Sec
6	<input checked="" type="checkbox"/>	Output6	1) Normal Mode N/O	0	Sec
7	<input checked="" type="checkbox"/>	Output7	1) Normal Mode N/O	0	Sec
8	<input checked="" type="checkbox"/>	Output8	1) Normal Mode N/O	0	Sec
9	<input checked="" type="checkbox"/>	Output9	1) Normal Mode N/O	0	Sec
10	<input checked="" type="checkbox"/>	Output10	1) Normal Mode N/O	0	Sec
11	<input checked="" type="checkbox"/>	Output11	1) Normal Mode N/O	0	Sec
12	<input checked="" type="checkbox"/>	Output12	1) Normal Mode N/O	0	Sec
13	<input checked="" type="checkbox"/>	Output13	1) Normal Mode N/O	0	Sec
14	<input checked="" type="checkbox"/>	Output14	1) Normal Mode N/O	0	Sec
15	<input checked="" type="checkbox"/>	Output15	1) Normal Mode N/O	0	Sec
16	<input checked="" type="checkbox"/>	Output16	1) Normal Mode N/O	0	Sec

- **Enable:** Select to enable this Output function to be used by GV-I/O Box.
- **Name:** Edit the name of the Output.
- **Output Mode:** Configure the input to **NC** (normally closed) or **NO** (normally open) mode.
 - ⊙ **Normal Mode (N/O and N/C):** Output continues to be triggered until the source of the output condition is stopped.
 - ⊙ **Toggle Mode (N/O and N/C):** Output continues to be triggered until a new input trigger ends the output.
 - ⊙ **Pulse Mode (N/O and N/C):** Output is triggered for the amount of time set in the **Pulse Mode Delay Time (1-60)** field.
- **Pulse Mode Delay Time (1-60):** Enter the time in seconds for the pulse delay time between 1 and 60 seconds.

Click **Submit** button to save the changes, or click **Cancel** button to return the changes to its previous state.

In/Out Monitor

In the left menu, click **In/Out Monitor**. This page appears.

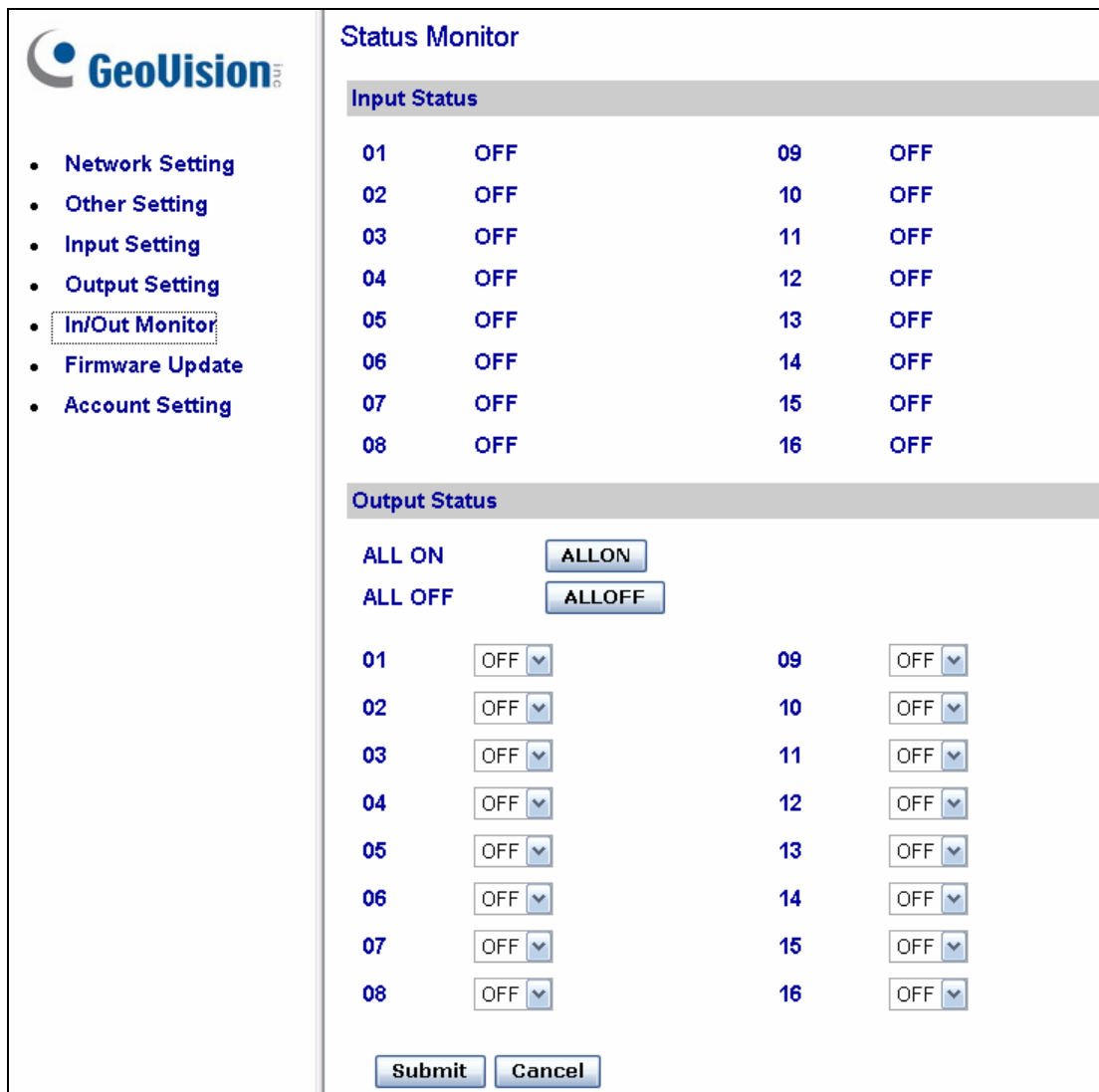

Status Monitor

Input Status

01	OFF	09	OFF
02	OFF	10	OFF
03	OFF	11	OFF
04	OFF	12	OFF
05	OFF	13	OFF
06	OFF	14	OFF
07	OFF	15	OFF
08	OFF	16	OFF

Output Status

ALL ON

ALL OFF

01	OFF	09	OFF
02	OFF	10	OFF
03	OFF	11	OFF
04	OFF	12	OFF
05	OFF	13	OFF
06	OFF	14	OFF
07	OFF	15	OFF
08	OFF	16	OFF

- **Input Status:** Indicates the current status of the 16 inputs, whether it is **On** (triggered) or **OFF** (no input).
- **Output Status:** Indicates the current status of the 16 outputs, whether it is **ON** (triggered) or **Off** (no output). Click **ALL ON** button to force all 16 outputs to be triggered. Click **ALL OFF** button to turn off all 16 outputs. Select the individual outputs to turn it **ON** to force the output to be triggered or turn it **OFF**.

Click **Submit** button to save the changes, or click **Cancel** button to return the changes to its previous state.

Updating Firmware

IMPORTANT: For firmware update from Version 1.0 to the latest version, it is required to access the GV-I/O Box over the network on Windows XP.

To update the firmware of GV-I/O Box, follow the steps below:

1. In the left menu, click **Firmware Update**. This page appears.

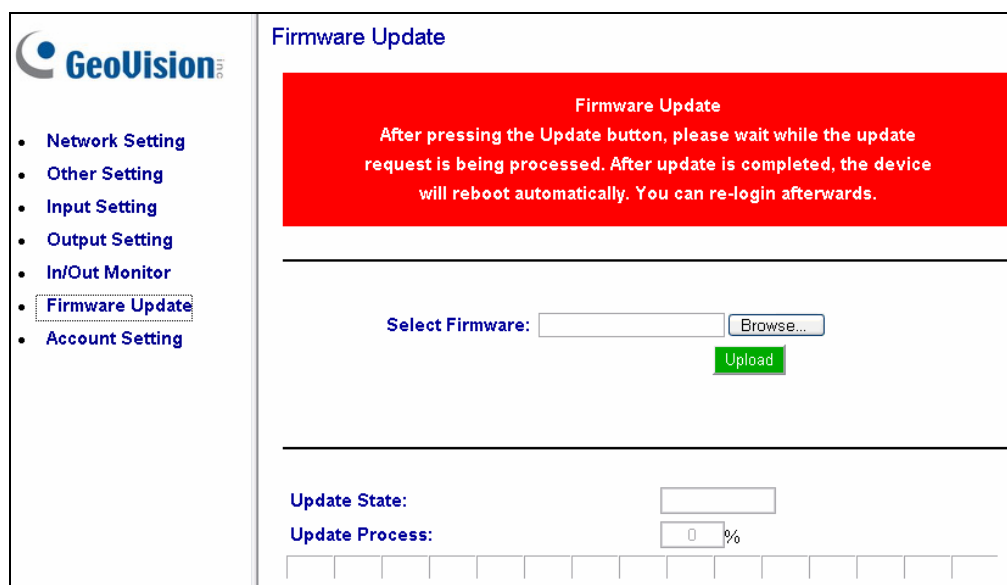

The screenshot shows the 'Firmware Update' page in the GeoVision web interface. On the left is a navigation menu with the following items: Network Setting, Other Setting, Input Setting, Output Setting, In/Out Monitor, **Firmware Update** (highlighted), and Account Setting. The main content area is titled 'Firmware Update' and contains a red warning box with the text: 'Firmware Update. After pressing the Update button, please wait while the update request is being processed. After update is completed, the device will reboot automatically. You can re-login afterwards.' Below this is a 'Select Firmware:' label followed by a text input field and a 'Browse...' button. A green 'Upload' button is positioned below the input field. At the bottom, there are two progress indicators: 'Update State:' with an empty input field, and 'Update Process:' with a progress bar showing '0 %'.

2. Click the **Browse...** button to open the firmware file (*.bin)
3. Click the **Upload** button. This update procedure may take 60 seconds to complete.
4. When the Update is complete, a dialog box appears and asks you to reboot the system.
5. Click **OK**. GV-I/O Box starts the Reboot operation.

Note: It is required to reboot GV-I/O Box after updating the firmware. Without rebooting, the firmware update is not complete.

Changing Login ID and Password

In the left menu, click **Account Setting**. This page appears. You can modify the login name and password. The password is case sensitive and is limited to 4 characters with the choices of “a ~ z” and “0 ~ 9”.

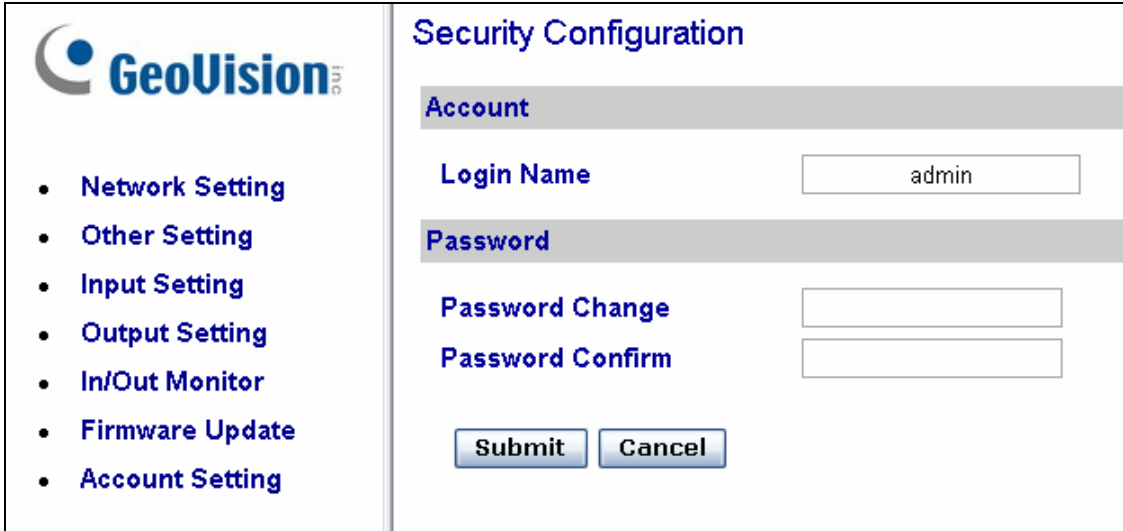

Specifications

OS	32-bit	Windows XP / Vista / 7 / 8 / Server 2008	
	64-bit	Windows 7 / 8 / Server 2008 R2 / Server 2012	
Input	Input	8	
	Input Signal	Dry Contact Wet Contact, 9-30V AC/DC	
Output	Relay Output	8	
	Relay Status	Normal Open	
	Relay Capacitance	USB Connection	30V DC, 3A
RS-485 Connection		125 / 250V AC, 3A 30V DC, 3A	
Ethernet		RJ-45, 10/100 Mbps (Optional)	
DC IN		DC 12V, 1A	
Address		0-9, A-F	
Terminal Resistance		120Ω	
Operating Temperature		0° C ~50° C / 32°F ~122 °F	
Humidity		5% ~ 95% (Non-Condensing)	
Dimensions (W x H x D)		135 x 28 x 145 mm / 5.31 x 1.10 x 5.70 in	